

# ATK-Logic User Manual

High Performance Logic Analyzer

**ALIENTEK**

ATK-Logic User Manual

## 修订历史

Version	Date	Author	Modify
V1.0	2023.5.10	TuLei	First release
V1.1	2023.7.29	LiJunJie	Modify the Ubuntu installation method
V1.2	2023.8.2	LiJunJie	Add some functions, modify the threshold formula
V1.3	2023.8.14	LiJunJie	Added cross-channel measurement, custom protocol
V1.4	2023.10.18	LiJunJie	Added view following and advanced protocol syntax search
V1.5	2024.3.4	TuLei	Added instructions for using shielded wires
V1.6	2024.10.14	TuLei	<ol style="list-style-type: none"><li>1. Added DL32 product description</li><li>2. Added product mechanical dimension drawing</li><li>3. Added stop mode introduction</li><li>4. Added roll mode description</li><li>5. Added advanced function description</li><li>6. Added glitch filtering calculation formula description</li><li>7. Change the trigger condition to simple trigger</li></ol>

## Table

Table .....	1
1, Product Description .....	1
1.1 Logic Analyzer.....	1
1.2 Parameters.....	2
1.2.1 DL16 .....	2
1.2.2 DL32 .....	3
1.3 Interface Description.....	4
1.3.1 DL16 .....	4
1.3.2 DL32 .....	5
1.4 Mechanical Dimensions.....	7
1.4.1 DL16 .....	7
1.4.2 DL32 .....	7
2, Software (ATK-Logic) .....	8
2.1 Introduction.....	8
2.2 Download.....	9
2.3 Install.....	9
2.3.1 Windows.....	9
2.3.2 Ubuntu.....	12
2.3.3 Mac.....	14
2.4 Block Diagram .....	15
2.5 Language.....	16
2.6 Theme.....	17
3, Hardware Connection .....	18
3.1 Shielded wire usage instructions.....	18
3.1.1 DL16 Wiring Instructions.....	18
3.1.2 DL32 Wiring Instructions.....	20
3.2 Channel connection (Reduce distractions) .....	21
3.3 Connect Computer.....	21
3.4 Test System.....	22
4, Quick Start.....	24
5, Function.....	28
5.1 Operating mode.....	28
5.2 Stop Mode.....	29
5.3 Collection method.....	30
5.3.1 Normal.....	30
5.3.2 Auto.....	31
5.3.3 Instant.....	32
5.3.4 Roll32 .....	
5.4 Data Compression.....	33
5.5 Channel Selection.....	33
5.6 Sampling Time.....	34

5.7 Sampling frequency.....	35
5.8 Sampling Depth.....	36
5.9 Trigger Threshold.....	37
5.10 Trigger Position.....	37
5.11 Simple Trigger.....	38
5.12 Advanced Trigger.....	39
5.12.1 Parallel triggering.....	39
5.12.2 Serial trigger.....	42
5.13 Glitch filter.....	44
5.14 Waveform viewing.....	45
5.15 Waveform Measurement.....	46
5.15.1 Mouse Measurement.....	46
5.15.2 Cross-Channel Measurement.....	46
5.15.3 Label Measurement.....	47
5.15.4 Parameter Measurement.....	47
5.16 Protocol Decoding.....	48
5.16.1 Add Protocol.....	48
5.16.2 Tips and Small Features.....	52
5.16.3 Protocol Settings Explanation.....	52
5.16.4 Custom Protocol Development (Secondary Development).....	53
5.16.5 Protocol Debugging.....	53
5.17 Data Search.....	54
5.18 PWM Output.....	54
5.19 Channel Color.....	55
5.20 File Saving.....	55
5.21 Habitual Settings.....	56
5.22 Hot Key.....	57
5.23 Firmware Update.....	57
5.24 Software update.....	58
6, Others .....	58

# 1, Product Description

## 1.1 Logic Analyzer

Logic Analyzer is an instrument for testing and analyzing digital circuit signals. It is mainly used to capture, display and analyze timing and waveform data of digital signals to help engineers diagnose faults, verify circuit designs and optimize system performance.

The main features and functions of the logic analyzer are as follows:

- **Signal Capture:** A logic analyzer is capable of capturing data from multiple digital signal channels simultaneously. It typically has multiple input channels, each capable of capturing an independent signal. These signals can be clock signals, data lines, control lines, and more.
- **High-Speed Sampling:** A logic analyzer can capture signals at high sampling rates, often reaching several hundred megahertz or even higher. High-speed sampling allows for precise capture of fast signal transitions and details, aiding in the analysis of signal timing relationships and logic issues.
- **Timing Analysis:** Logic analyzers can display timing diagrams of captured signals. Timing diagrams show how signals change over time, helping engineers observe timing relationships between signals, detect time delays between signals, pulse widths, and more.
- **Waveform Analysis:** Logic analyzers can display signal waveforms in graphical form. Waveform graphs show changes in signal levels and pulse shapes, allowing engineers to assess signal level stability, noise interference, pulse widths, and other characteristics.
- **Trigger Functionality:** Logic analyzers typically include trigger functionality, allowing users to set trigger conditions to capture specific signal events. Trigger functionality helps engineers locate and capture signals of interest within a large volume of signal data.
- **Protocol Analysis:** Logic analyzers also feature protocol analysis capabilities, enabling the decoding and analysis of common communication protocols such as UART, SPI, I2C, CAN, and more. This feature helps engineers intuitively understand and analyze communication data.
- **Storage and Playback:** Logic analyzers often have internal memory for storing captured signal data. Stored data can be replayed and analyzed later, facilitating offline analysis and troubleshooting.
- **Software Support:** Logic analyzers typically come with dedicated software for instrument control, signal data display, and analysis functions.

## 1.2 Parameters

### 1.2.1 DL16

Specifications			
Model		DL16	DL16 Plus
Channel		16ch	
Communication Interface		Type-C USB2.0	
Maximum Sampling Rate	Buffer	250MHz (16ch)	1GHz (8ch) 500MHz (16ch)
	Stream	100MHz (3ch) 50MHz (6ch) 20MHz (16ch)	100MHz (3ch) 50MHz (6ch) 20MHz (16ch)
Minimum Detectable Pulse Width		8ns	2ns
Maximum Detectable Frequency		50MHz	200MHz
Hardware Storage Depth		1G(bit)	3.5G(bit)
Maximum Sampling Depth	Buffer	1G(bit) (RLE can effectively increase the sampling depth.)	3.5G(bit) (RLE can effectively increase the sampling depth.)
	Stream	Depends on the computer's memory size.	
Data Mode		Buffer(High Sampling Rate) / Stream(Long Sampling Time)	
Sampling Accuracy		$\pm$ One Sampling Period	
Trigger Type		Rising/Falling/High/Low/Any Edge	
Protocols		170+ (Open Source)	
Input Voltage		-40V ~ +40V	
Input Impedance		250K/15pF	
Adjustable Threshold		-5V ~ +5V (0.1V Step)	
PWM		1Hz ~ 20MHz (Fixed 3.3V), Dual Channels	
Channel Interface		2.54mm	
Supply Voltage		5V $\pm$ 0.2V	
Supply Current		250mA (@5V max)	
Dimensions		L*W*H: 75*53*12 (mm)	
Temperature		0~70°C (Operating)	

## 1.2.2 DL32

Specifications					
Model		DL32		DL32 Plus	
Channel		16ch		32ch	
Communication Interface		Type-C USB3.0			
Maximum Sampling Rate	Buffer	8ch/1Ghz 12ch/800MHz 16ch/500MHz		12ch/1GHz 15ch/800MHz 24ch/500MHz 30ch/400MHz 32ch/250MHz	
	Stream	USB3.0 3ch/1GHz 6ch/500MHz	USB2.0 3ch/100MHz 6ch/50MHz	USB3.0 3ch/1GHz 6ch/500MHz 12ch/250MHz	USB2.0 3ch/100MHz 6ch/50MHz
	Roll	12ch/250MHz 16ch/125MHz	16ch/20MHz	16ch/125MHz 30ch/100MHz 32ch/50MHz	16ch/20MHz 32ch/10MHz
Minimum Detectable Pulse Width		2ns			
Maximum Detectable Frequency		200MHz			
Hardware Storage Depth		3.5G(bit)			
Maximum Sampling Depth	Buffer	3.5G(bit) (RLE can effectively increase the sampling depth.)			
	Stream	Depends on the computer's memory size.			
Data Mode		Buffer(High Sampling Rate) / Stream(Long Sampling Time) Roll(Dynamic display of signal changes)			
Sampling Accuracy		± One Sampling Period			
Trigger Type		High, Low, Rising, Falling, Edge, Serial, Parallel			
Protocols		170+ (Open Source)			
Input Voltage		-40V ~ +40V			
Input Impedance		250K/15pF			
Adjustable Threshold		-5V ~ +5V(0.1V Step)			
PWM		1Hz ~ 20MHz(Fixed 3.3V), Four Channels			
Channel Interface		1.27mm Shielded wire			
Supply Voltage		5V ± 0.2V			
Supply Current		460mA (@5V max)			
Dimensions		L*W*H: 81*70.5*9 (mm)			
Temperature		0~70℃			

## 1.3 Interface Description

### 1.3.1 DL16



Indicator Light			
Red	Green	Blue	Off
Disconnected	Connected	Collecting	1、 Power Off 2、 Firmware Update

20PIN Interface				
Annotation	PWM0	PWM1	G	0-15
Introduction	PWM0 Output	PWM1 Output	GND	Channel

1.3.2 DL32



DL32 (16ch)

Indicator Light			
Red	Green	Blue	Off
Disconnected	Connected	Collecting	1、 Power Off 2、 Firmware Update

PIN Interface			
<b>Annotation</b>	P0 - P3		0-15
<b>Introduction</b>	PWM Output	GND	Channel



DL32 Plus (32ch)

Indicator Light			
Red	Green	Blue	Off
Disconnected	Connected	Collecting	2、 Power Off 2、 Firmware Update

PIN Interface			
<b>Annotation</b>	P0 - P3		0-31
<b>Introduction</b>	PWM Output	GND	Channel

## 1.4 Mechanical Dimensions

### 1.4.1 DL16

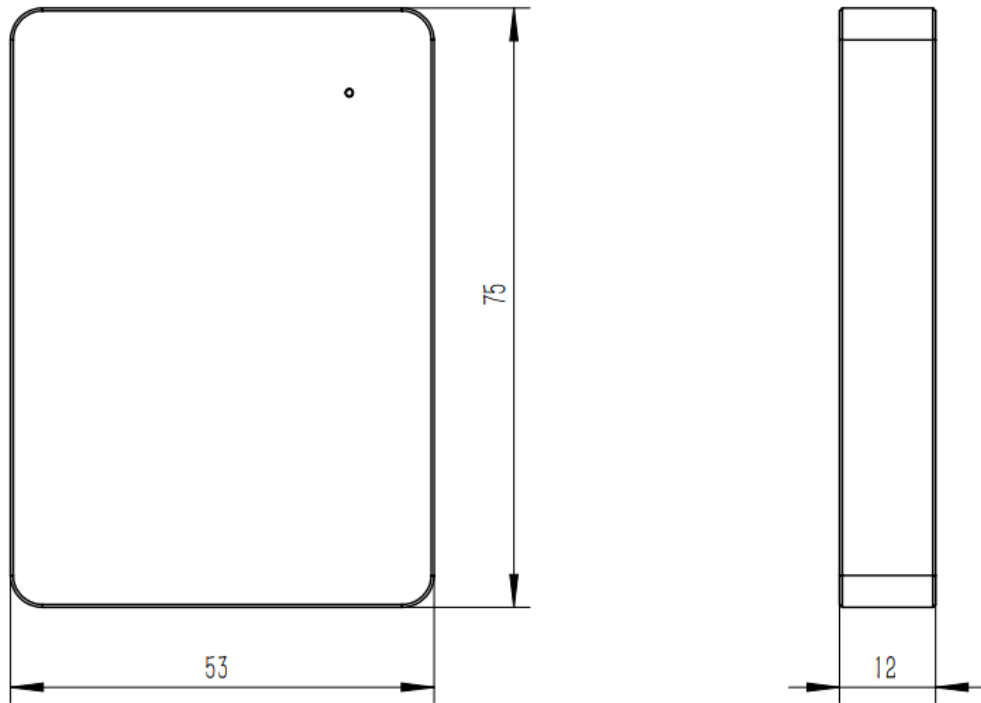

DL16

### 1.4.2 DL32

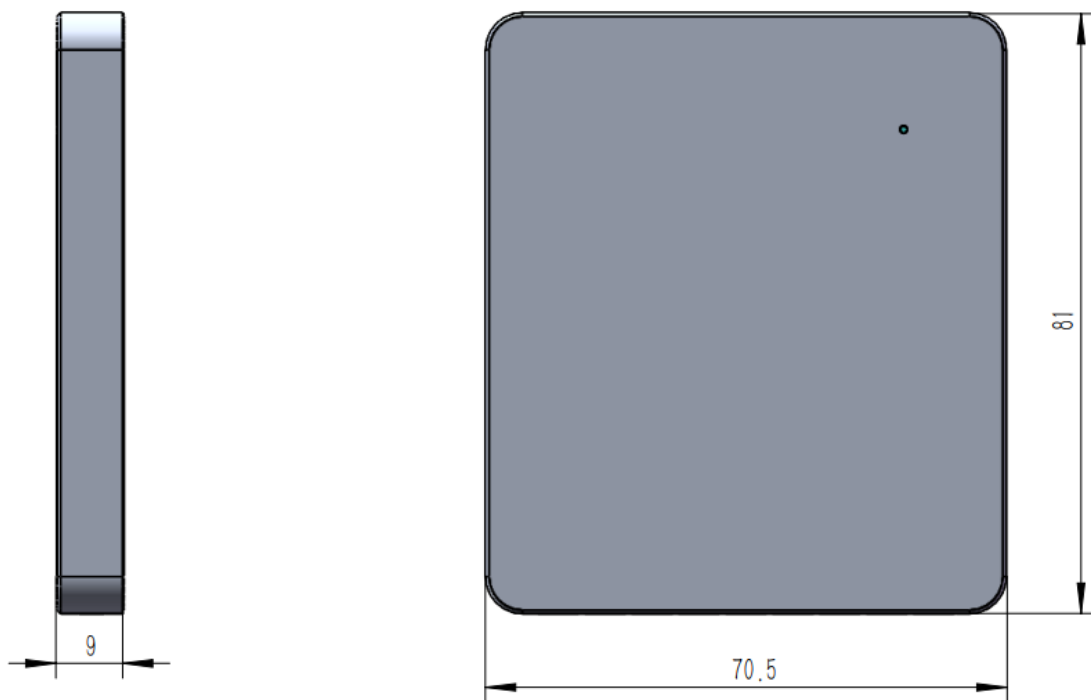

DL32

## 2, Software (ATK-Logic)

### 2.1 Introduction

ATK-Logic software is a powerful tool designed by the ALIENTEK team specifically for logic analyzers, aimed at assisting users in capturing, analyzing, and debugging logic signals. Whether you are an electronic engineer, embedded system developer, or circuit designer, this software provides you with powerful features and convenient operations.

Key features and functions:

1. **Signal Capture and Display:**The software can connect to the logic analyzer, capture real-time waveform data of logic signals, and display it. You can easily select the channels of interest and visually view and analyze the state and timing of signals.
2. **Advanced Signal Analysis:**In addition to basic waveform display capabilities, the software offers a range of advanced signal analysis tools. You can perform timing analysis, parameter measurements, protocol decoding, and more, helping you gain a deep understanding and resolve issues related to digital signals.
3. **Powerful Debugging:**The software provides a series of powerful debugging features, including signal triggering settings, buffer depth control, and more. These features help you accurately capture and analyze complex logic signals, speeding up the troubleshooting process.
4. **Data Export and Project Parameter Saving:**The software supports exporting captured signal data in common CSV file formats and can save raw BIN data for sampling points, making it easy to perform data analysis with other tools. Additionally, you can save project configurations to record the analysis process and results.

ATK-Logic software features an intuitive and user-friendly interface, making it easy to learn and operate. It provides users with an efficient working environment, simplifying the process of capturing, analyzing, and debugging logic signals. Whether you are a beginner or an experienced professional, this software can meet your needs. If you have any ideas or suggestions, please feel free to contact us.

## 2.2 Download

ATK-Logic software supports the mainstream systems currently on the market. If you are using a logic analyzer for the first time, please move to the link below to download the latest software.

**Download link:** <http://www.openedv.com/docs/tool/luojifenxiyi/index.html>

ATK-Logic software is compatible with the following operating systems:

- Windows: Win7/Win10/Win11
- Linux: Ubuntu 20.04 (and above)
- Mac: OS 10.14 (and above)

System requirements for ATK-Logic software are as follows:

- CPU: Minimum dual-core with a minimum clock speed of 3.0 GHz, recommended 4.0 GHz or higher
- RAM: 2 GB or more
- GPU: No specific requirements
- Hard Drive: 300 MB or more
- USB: USB 2.0 or higher

**Please note: If your computer's configuration is below the requirements mentioned above, the software's performance may be compromised!!!**

## 2.3 Install

### 2.3.1 Windows

**Warm reminder: When installing this software, the anti-virus software may report an abnormality reminder, which is a false alarm. Please temporarily exit the anti-virus software/select to allow this operation to complete the installation of this software.**

Double-click the downloaded exe file to open the installation program.

Choose the appropriate installation package based on your computer's system:

x32: ATK-Logic Vx.x.x\_x86.exe

x64: ATK-Logic Vx.x.x\_x64.exe

Where: Vx.x.x.x represents the version number.

- Choose the installation directory and click 'Next'.

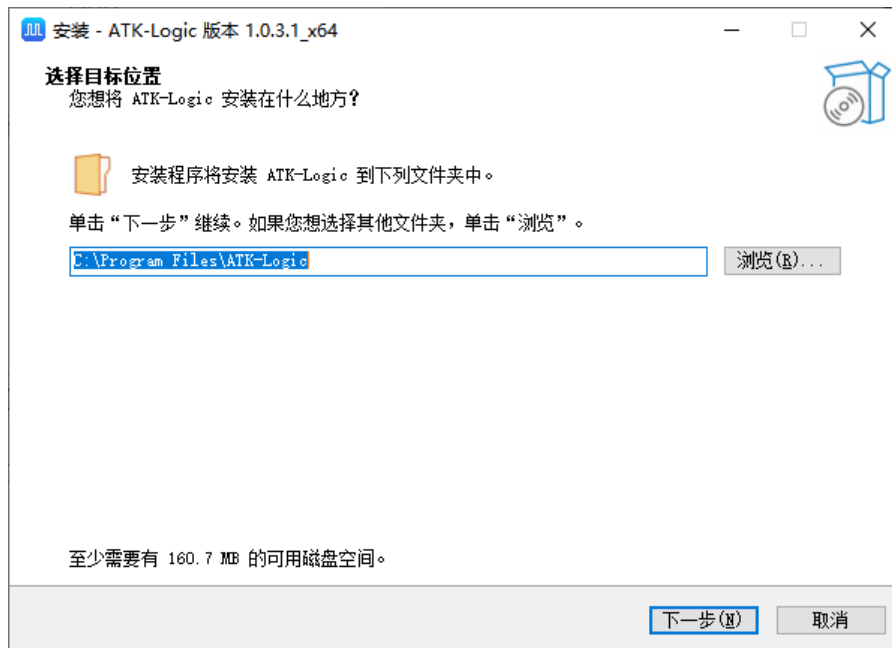

- Check the 'Install Driver' option (only required for Win7; Win8 and above are plug-and-play), and click 'Next'.

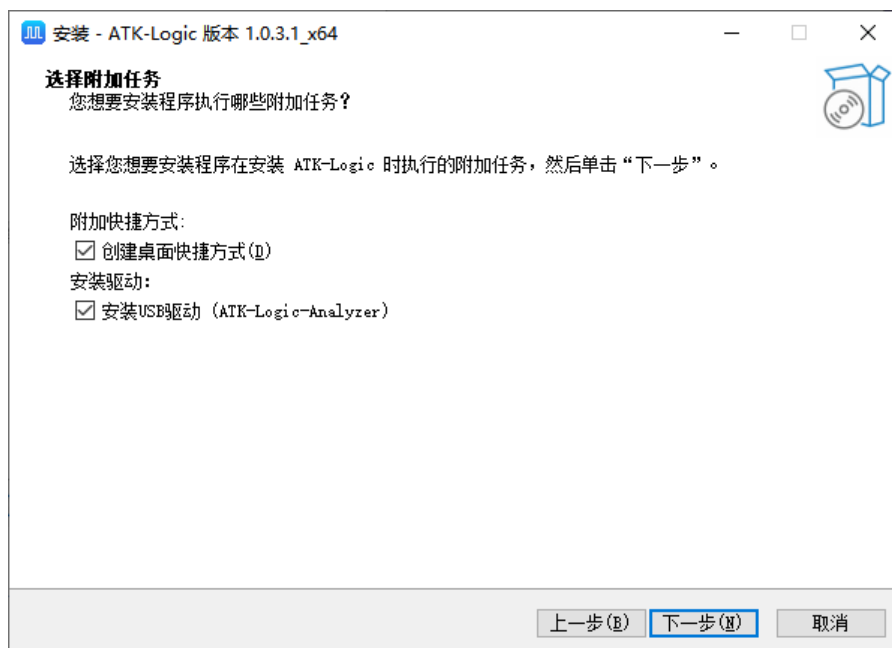

- Click 'Install' to begin the installation process and wait for it to complete.

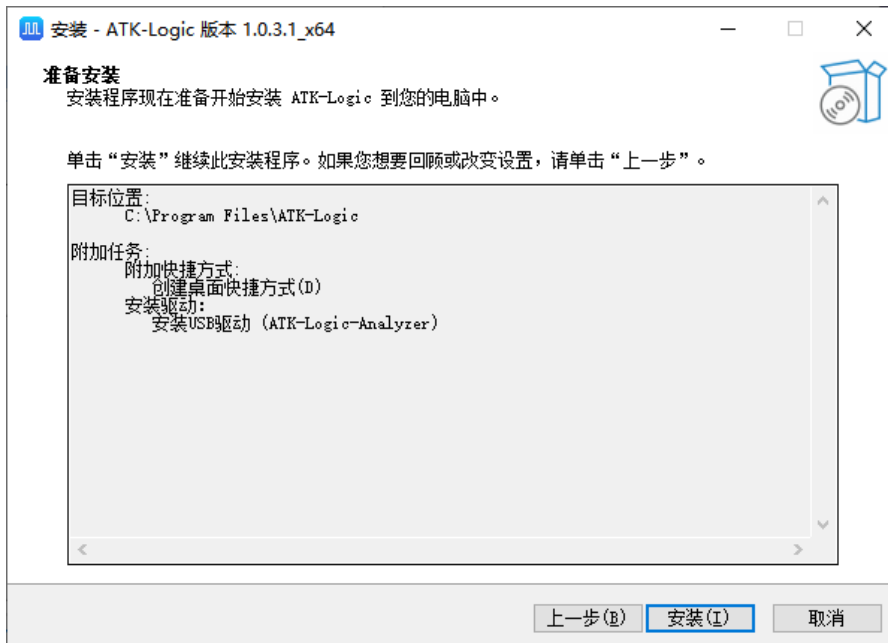

- Installation completed.



- After successful installation, you will see the ATK-Logic software icon on your desktop, as shown below.

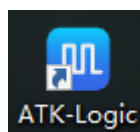

### 2.3.2 Ubuntu

- For Linux, the installation package is a .deb file. First, open the terminal and navigate to the directory containing the installation file. Then, execute the installation command. You will need to modify the file name in the command yourself.

```
sudo dpkg -i ATK-Logic_1.0.4.7_amd64.deb
```

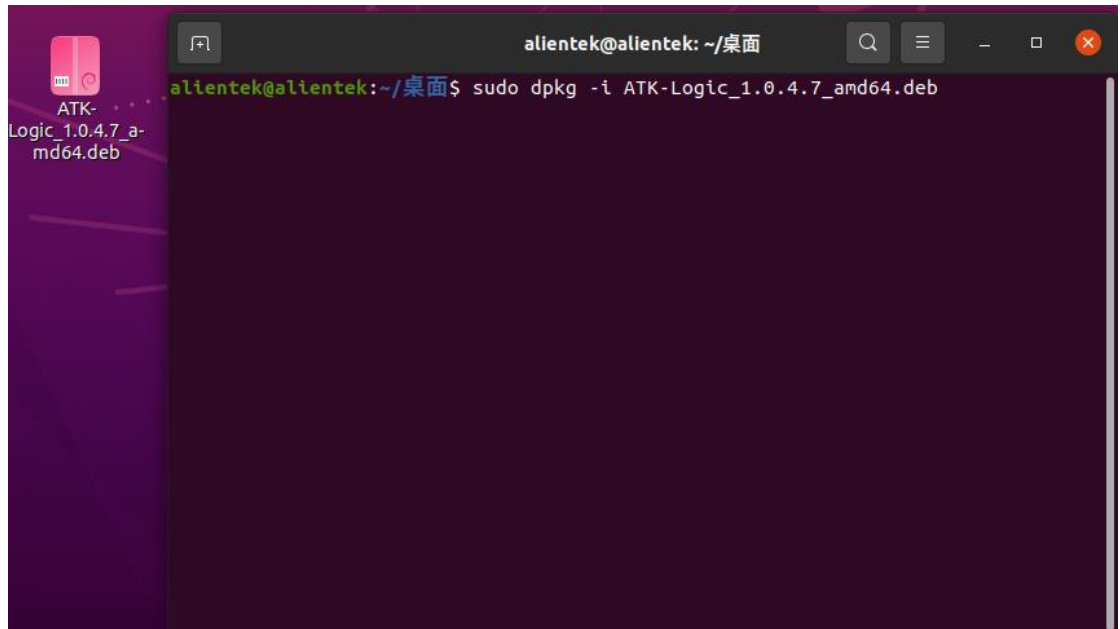

- Find the shortcut in the applications bar and open it.

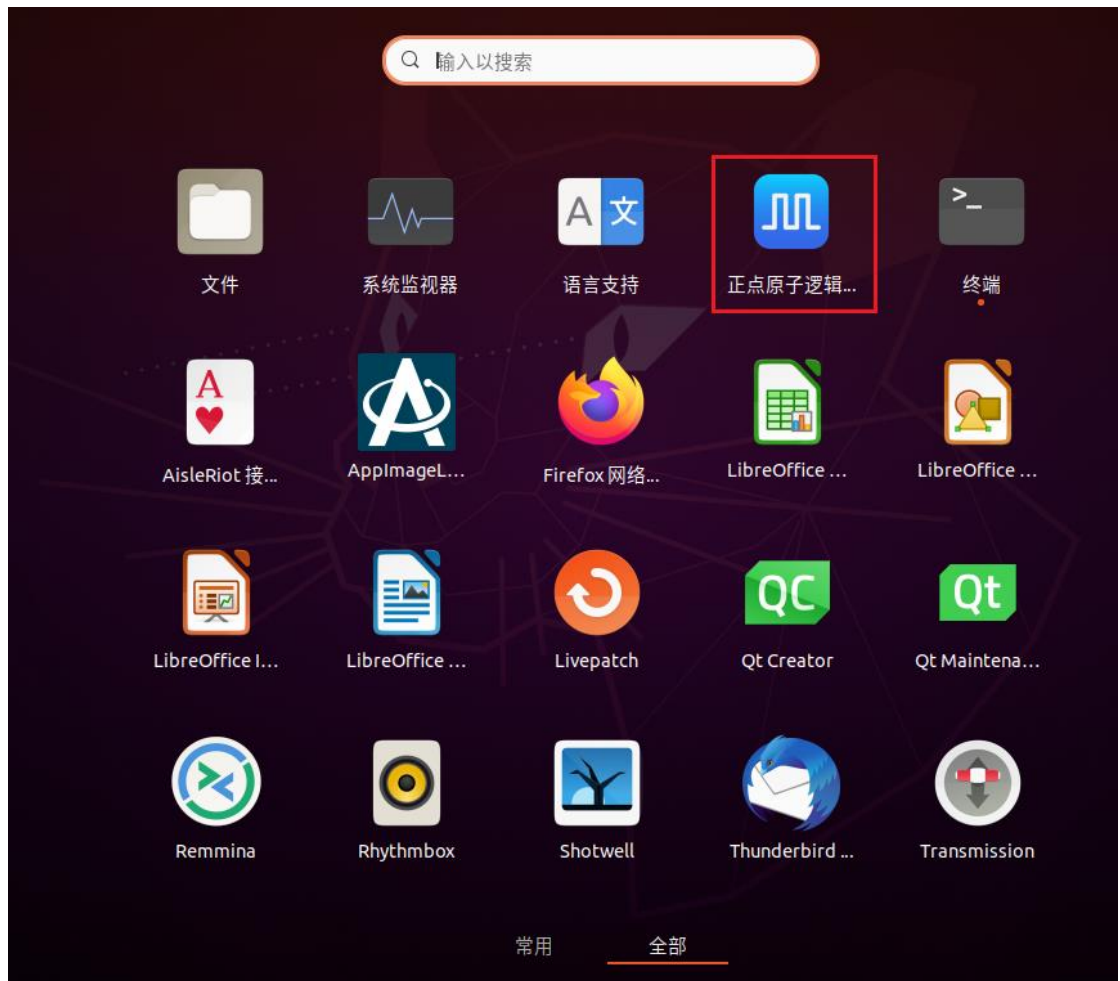

- To uninstall, please execute the following command:  
`sudo dpkg -r ATK-Logic`

### 2.3.3 Mac

- Open the installation program DMG image file.
- Drag the ATK-Logic icon into the Applications icon to complete the installation.



- After installation is complete, the program will appear in the Applications bar. Simply launch the program.

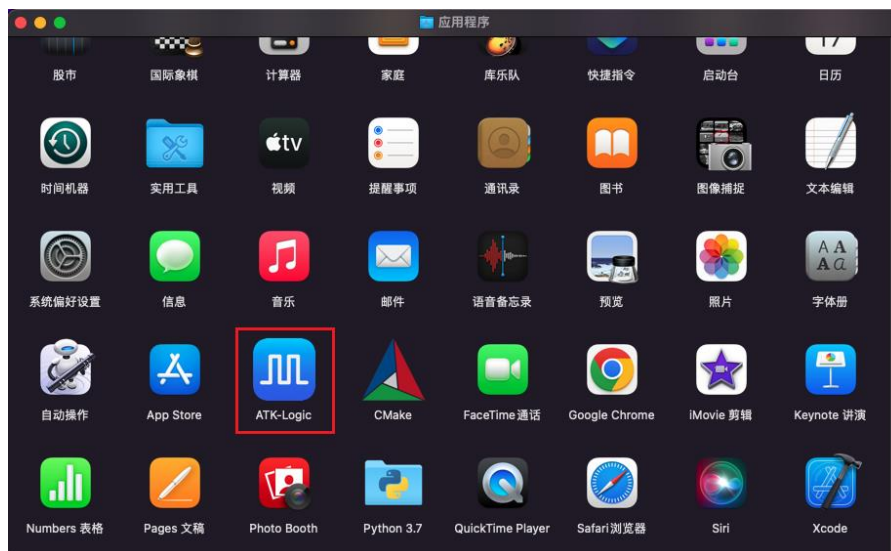

## 2.4 Block Diagram

ATK-Logic display frame is as shown in the following diagram.

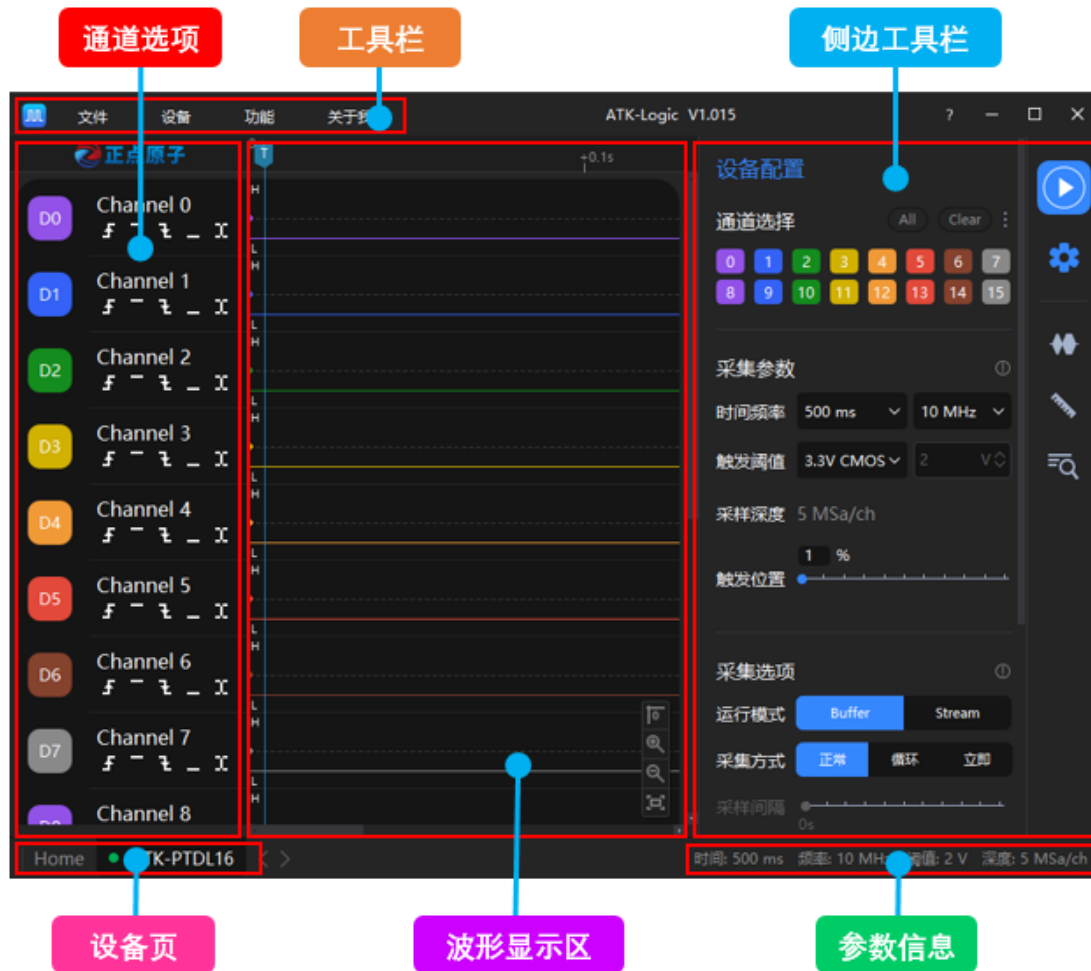

The software can be divided into the following main sections:

Region	Description
Tool	Common settings for devices and software, functions such as data import and export, and more.
Sidebar Tool	It includes functions such as the acquisition button, acquisition parameters, protocol decoding, measurements, and more. You can choose to display or hide these functions by clicking on the icons.
Channel Options	It includes functions such as configuring trigger conditions, adjusting channel order, modifying channel names, and more.
Waveform Area	The topmost section is the time axis, and the "H" and "L" on the far left indicate the current high and low voltage levels of the channels. The middle area displays waveform data and decoding information. In the bottom right corner, there are four shortcut buttons.
Device Page	You can choose different pages: Home, Connected Devices, Opened Files, and Projects.
Parameters	Display the acquisition parameters of the current device.

## 2.5 Language

ATK-Logic software supports two languages, Chinese and English, which can be set under the menu bar of "Function" -> "Language" in the upper left corner of the software interface.

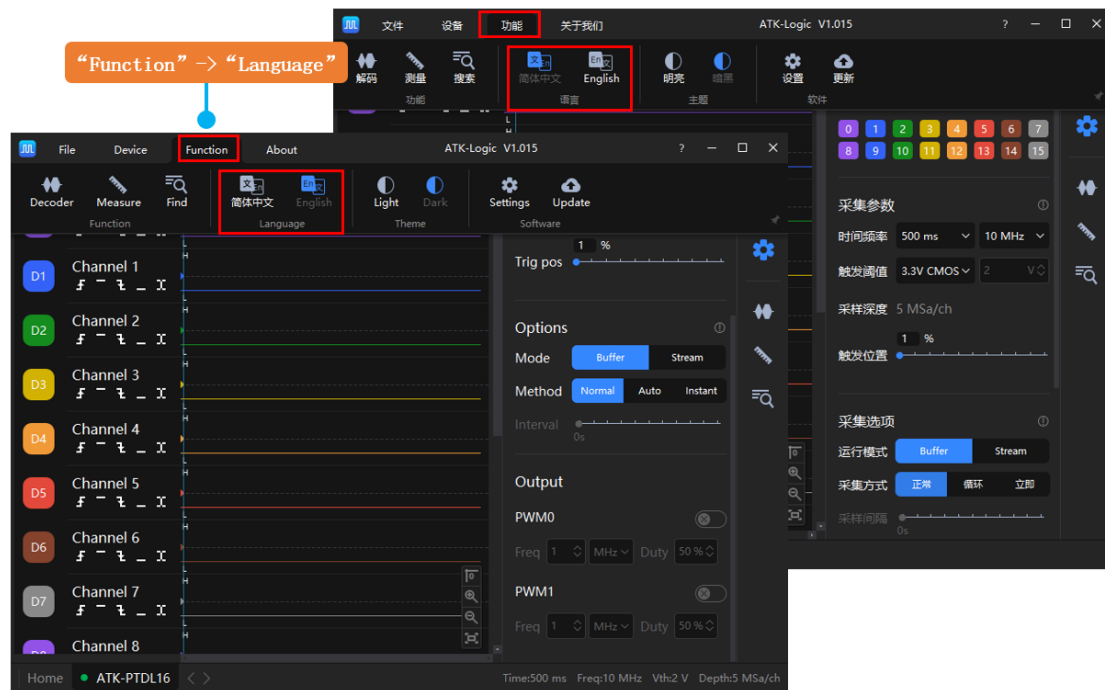

## 2.6 Theme

ATK-Logic software supports two themes: light and dark, which can be set under the "Function" -> "Theme" menu bar in the upper left corner of the software interface. The default theme of the software is: dark theme.

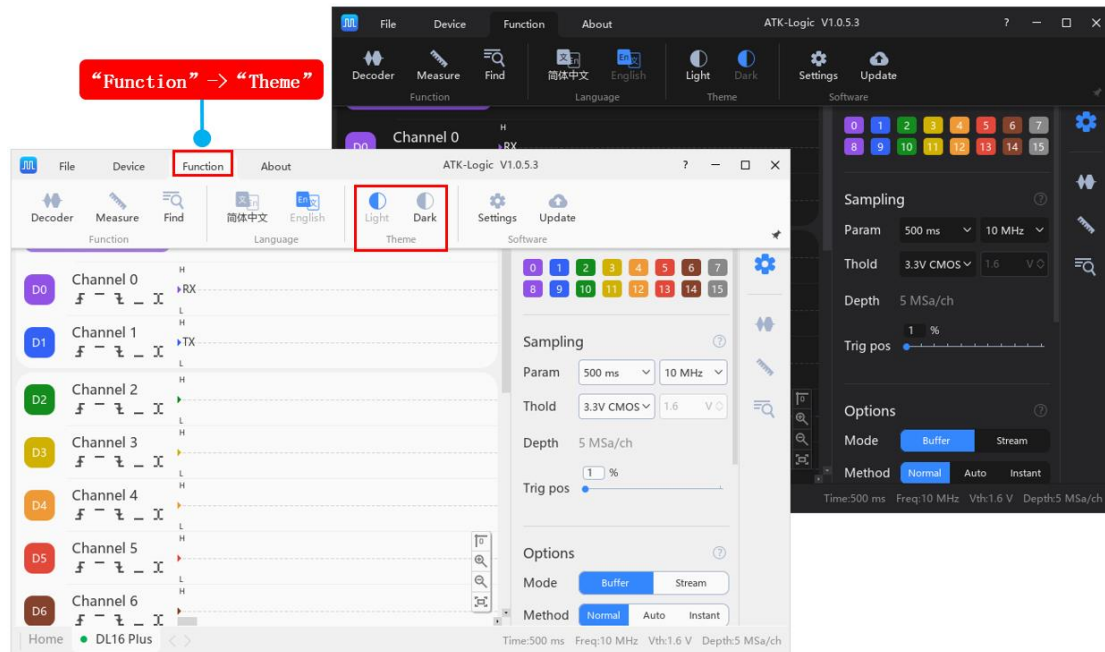

## 3, Hardware Connection

### 3.1 Shielded wire usage instructions

In order to ensure the integrity of the tested signal and minimize external interference, the logic analyzer provides accompanying shielding lines for user use. Friendly reminder: Shielding lines need to be purchased separately.

Notes :

- To ensure the integrity of the signal, make sure to connect the ground (GND) of each channel as close as possible during wiring for optimal effectiveness.
- It is essential to directly connect the shielding lines to the tested system; please refrain from "secondary splicing."

#### 3.1.1 DL16 Wiring Instructions

The shielded wire cannot be directly connected to the logic analyzer and requires an adapter board to be used together. The relevant accessories are as shown in the figure below:

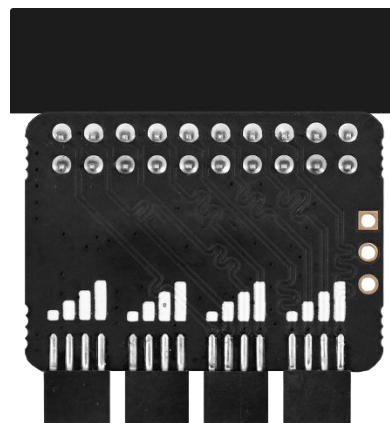
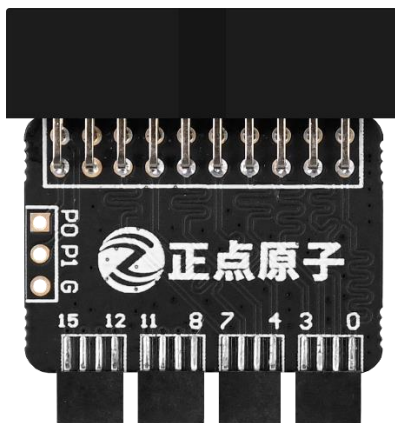

Adapter board



Shielded wire





Shielded wire detail: 1.27mm



Shielded wire detail: 2.54mm

### How to connect the shielded wire to the adapter board?'

Keep the marks on the adapter board and the shielded wire on the same side, and connect the shielded wire and the adapter board, as shown in the figure below.

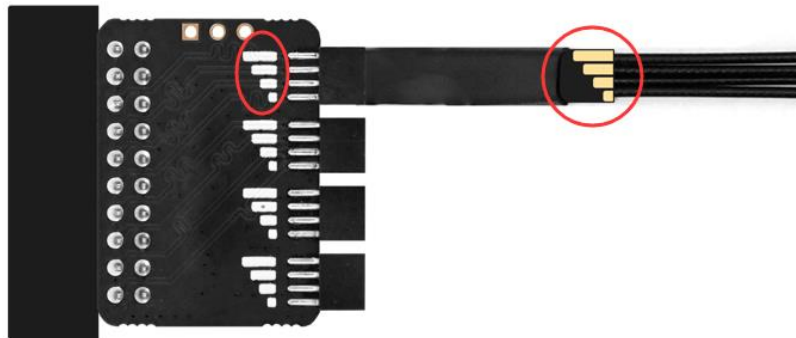

Connection Diagram

### Channel line description

- The colored DuPont line is the channel connection line (wrapped in white heat shrink tube)
- The black DuPont wire is the GND connecting wire (wrapped in black heat shrink tube)



3.1.2 DL32 Wiring Instructions



正面接线示意图



背面接线示意图

## 3.2 Channel connection (Reduce distractions)

When using a logic analyzer in practice, if you do not pay attention to the wiring method, it is likely to introduce a lot of glitches, causing the software unable to analyze the data. We provide the following methods to reduce the occurrence of glitches:

Methods		Description
Hardware Wiring	Direct Connection	<ol style="list-style-type: none"> <li>1. Keep the GND wiring as short as possible; connect it directly to the GND of the system under test without creating secondary connections.</li> <li>2. Connect the signal lines directly to the pin sockets of the logic analyzer whenever possible.</li> </ol>
	Multi-point Grounding	Distribute multiple GND channels to different locations within the system under test, avoiding connecting multiple GND channels to a single grounding point.
	Twisted Pair Wiring	Twisting all channel wires (including GND) tightly together.
	Cross Grounding	Connecting unused channels as GND channels to the system under test is recommended. The recommended wiring method involves cross-connecting signals with GND channels and placing signals between two GND channels, for example: GND - Signal - GND - Signal - GND - Signal - GND. Using a twisted pair wiring method along with this can yield even better results.
Software Filtering		When it's challenging to address glitches through hardware modifications, you can try using software filtering to eliminate spurious pulse signals. For detailed information, please refer to the user manual.

## 3.3 Connect Computer

The steps to connect the logic analyzer to the computer are as follows:

1. Connect the TypeC interface of the logic analyzer to the USB port of the computer through the USB Type-C data cable, and confirm whether the hardware indicator light is on. If the upper computer is not turned on, the indicator light is **red**.

### Precautions:

Use original USB data cables as much as possible, and avoid using USB HUB expansion devices to avoid unstable device connections.

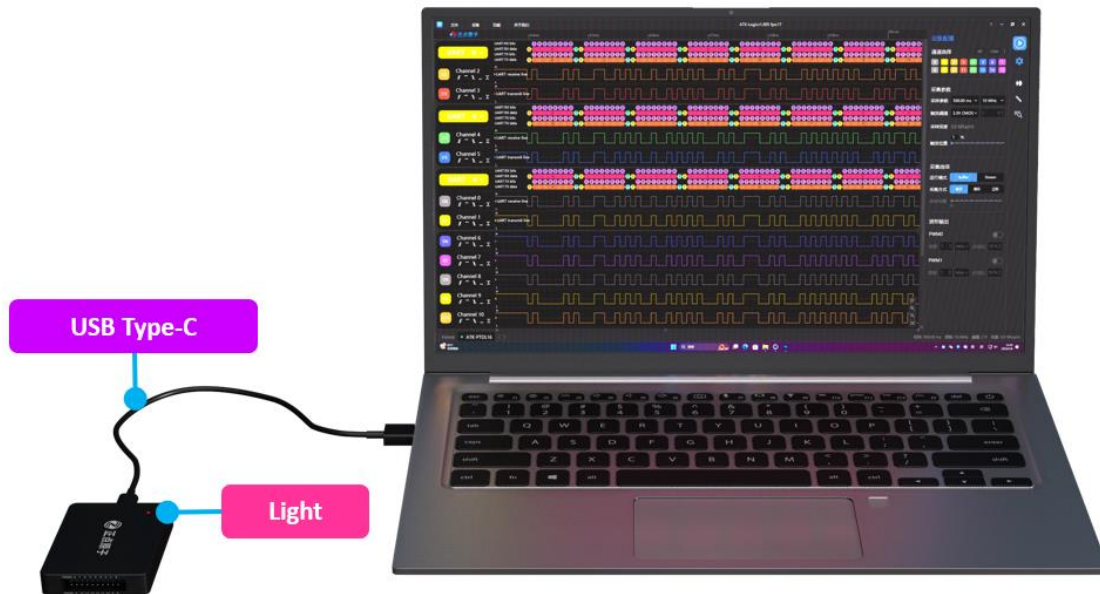

2. Open the ATK-Logic software; it will automatically recognize and connect to the logic analyzer. You will receive a notification in the lower-left corner of the software indicating whether the device has connected successfully. Wait for the device to connect successfully; the device indicator light will turn **green**, and the software's lower-left corner will display 'Device connected successfully' and create a new device page.

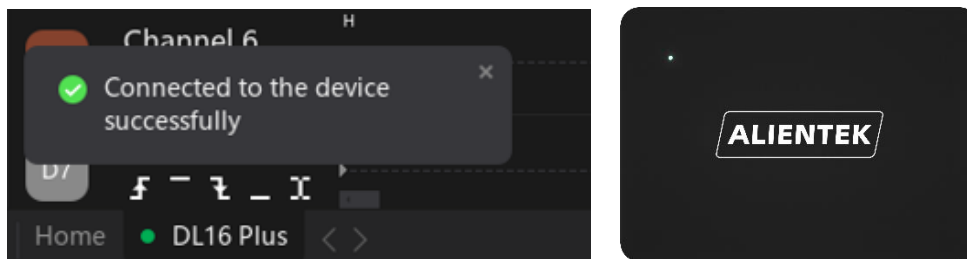

### 3.4 Test System

#### Special Note:

The logic analyzer shares a common ground with the computer. When testing high-voltage systems, please use a 'USB isolator' to implement proper isolation measures. Otherwise, there is a high risk of damaging the logic analyzer or the computer!!!

When connecting the logic analyzer to the system under test, please consider the following points:

1. Ensure a reliable and short connection between the GND channel of the logic analyzer and the GND of the system under test.
2. Ensure that the signal channels are reliably connected to the test signal points of the system under test and avoid arbitrary 'splicing' that may introduce interference.
3. Channels 0-15 can be wired freely and can be configured to correspond to the channels later through software settings.

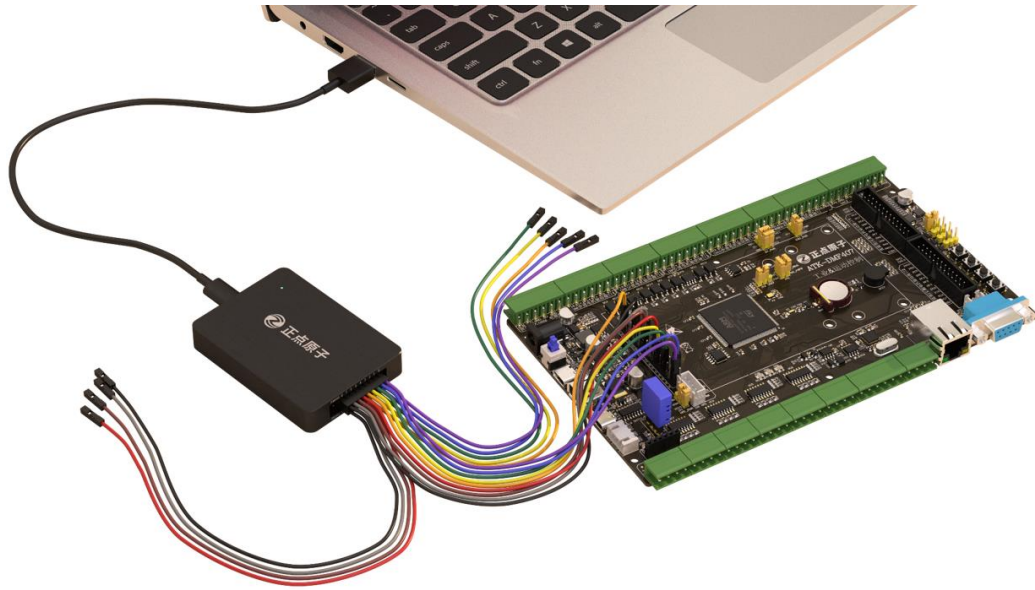

## 4, Quick Start

1. Connect the logic analyzer to the device under test. Please refer to sections 3.1 and 3.3 for details.

**Special Note: Ensure that the voltage of the system under test does not exceed the input voltage tolerance of the logic analyzer, as it may cause permanent damage to the device.**

2. Connect the logic analyzer to the computer. Please refer to section 3.2 for details.

**Special Note: The logic analyzer shares a common ground with the computer. When testing high-voltage systems, please use a 'USB isolator' to implement proper isolation measures. Otherwise, there is a high risk of damaging the logic analyzer or the computer!!!**

3. Open the ATK-Logic software and connect to the logic analyzer.

Once the device is successfully connected to the software, you will receive a 'Device connected successfully' message in the lower-left corner, and a new device page will be added.

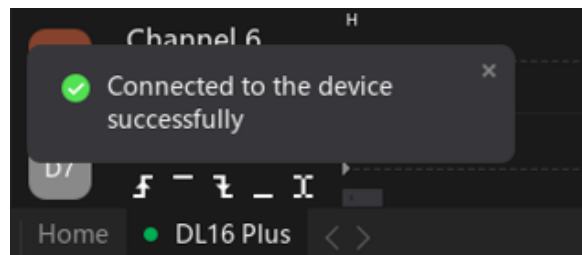

4. Configure the basic acquisition parameters.

Open the 'Device Configuration' interface in the right-hand toolbar. Choose the channels you want to enable, set the acquisition time, sampling frequency, and configure an appropriate trigger threshold (typically half of the signal amplitude). Select the operating mode and acquisition method. Here's an example for capturing serial data (3.3V level / 115200 baud rate / TX data line):

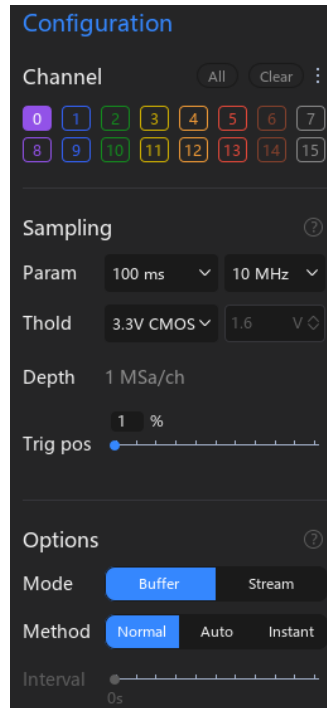

- **Channel Configuration:** Since only one data line needs to be captured, use channel 0 (0ch).
- **Acquisition Time:** Choose an appropriate time based on your needs; here, select 100ms.
- **Sampling Frequency:** The tested signal has a baud rate of 115200. Choosing a 10MHz sampling rate provides good accuracy, and the data volume won't be too large (recommended to be greater than 10 times the tested signal frequency).
- **Trigger Threshold:** The tested signal has a 3.3V voltage level (high level at 3.3V, low level at 0V). The most suitable threshold calculation is:  $(3.3V - 0V) * 0.5 + 0V = 1.65V$ , so set it to 1.6V.
- **Operating Mode:** Choose according to your needs; here, real-time waveform observation is not required, so select the Buffer mode.
- **Acquisition Method:** Choose according to your needs; here, only one capture is needed, so the default normal mode is sufficient.

## 5. Start the Acquisition

Click the 'Start Acquisition' button in the right-hand toolbar to begin data acquisition. If you have set a relatively long acquisition time, you can observe the entire acquisition progress of the logic analyzer.

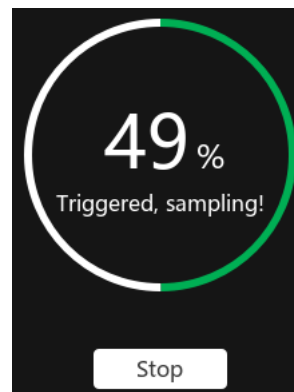
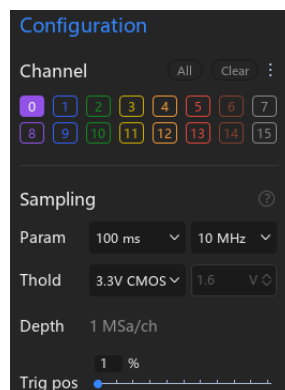

## 6. Waveform Viewing and Operations

After data acquisition is complete, the software will render the data directly in the waveform display area, as shown in the figure below. The upper computer provides a series of waveform zooming, waveform dragging, and local zooming functions. For detailed operations, please refer to the '5.12 Waveform Viewing and Operations' section. The adjusted waveform is as shown below:

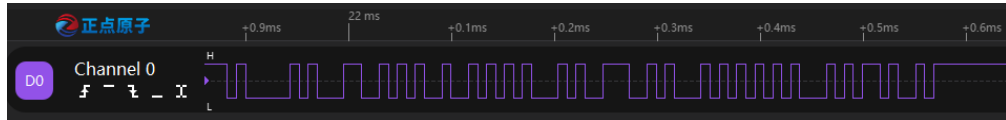

## 7. Adding Protocol Decoders

One of the most important functions of the logic analyzer is to automatically decode waveform data. You can open the 'Protocol Decoding' -> 'Protocol' -> 'Add' from the right-hand toolbar. Since we need to decode serial data here, select 'UART' to open the protocol settings interface. Set the channel, baud rate, and other parameters based on the serial information. Here, we only modified the following parameters (you can adjust others as needed):

- UART transmit line: Select 0ch and connect the serial port TXD data line
- Baud rate: Change to 115200, consistent with the actual serial port baud rate

As shown in the figure below, set the parameter information and click "OK".

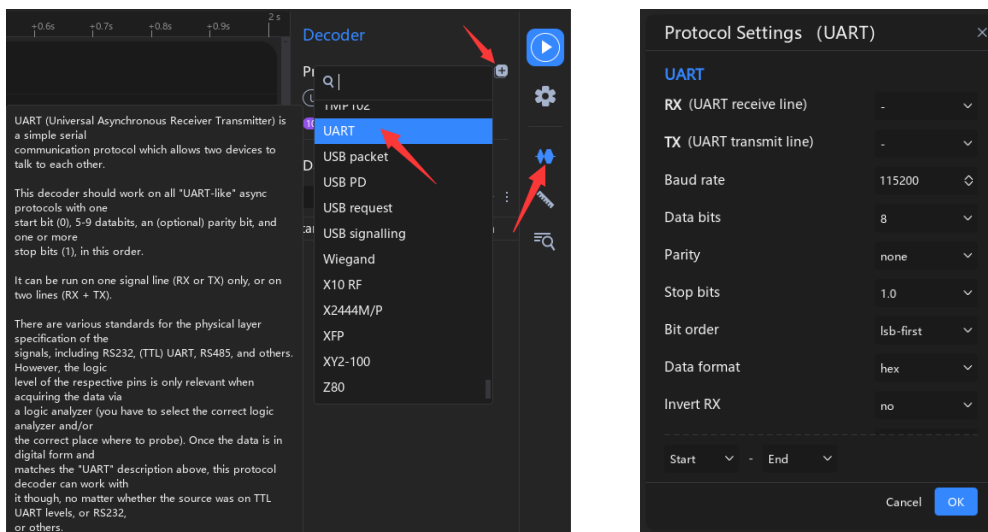

## 8. Protocol decoding data display

The successfully decoded data is shown in the figure below:

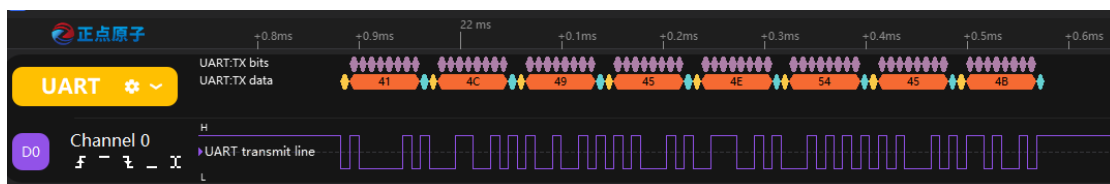

The hexadecimal data in the above picture is not convenient to view. If the serial port data is a string, you can change the "Data format" parameter to "ascii" in the protocol settings to decode the string data.



## 5, Function

### 5.1 Operating mode

The logic analyzer supports two operating modes: Buffer mode and Stream mode. Select under "Configuration" -> "Options" -> "Mode", as shown in the figure below:

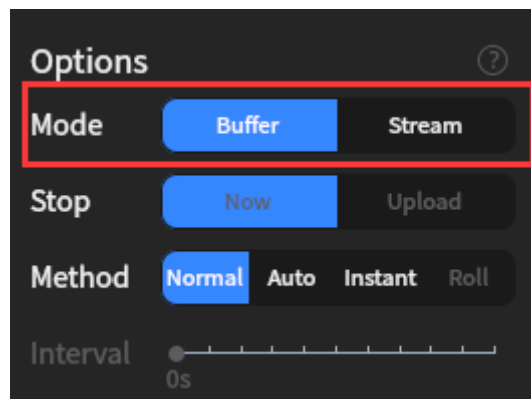

- **Buffer mode:** In this mode, the logic analyzer first stores the sampled data into the hardware memory, and then uploads it to the host computer after all the preset sampling depths are collected. Since the data is not collected and transmitted, the maximum sampling rate of this mode is not limited by the USB speed, and the sampling rate is much higher than that of the Stream mode. Similarly, the Buffer mode also has shortcomings. The sampling depth is limited by the size of the hardware memory capacity and cannot be very large. However, the Buffer mode supports the RLE compression function, which can increase the sampling depth of the Buffer mode when the frequency of the signal under test is not very high.
- **Stream mode:** In this mode, data is collected and transmitted to the computer via USB at the same time. Since the data does not need to be stored in the hardware memory, the sampling depth can be very large. In theory, the amount of data can be collected as much as the computer memory is. However, this mode also has disadvantages. The sampling speed is limited by the USB transmission speed, and the sampling rate cannot be very high. (Protocol synchronous decoding is supported in this mode)

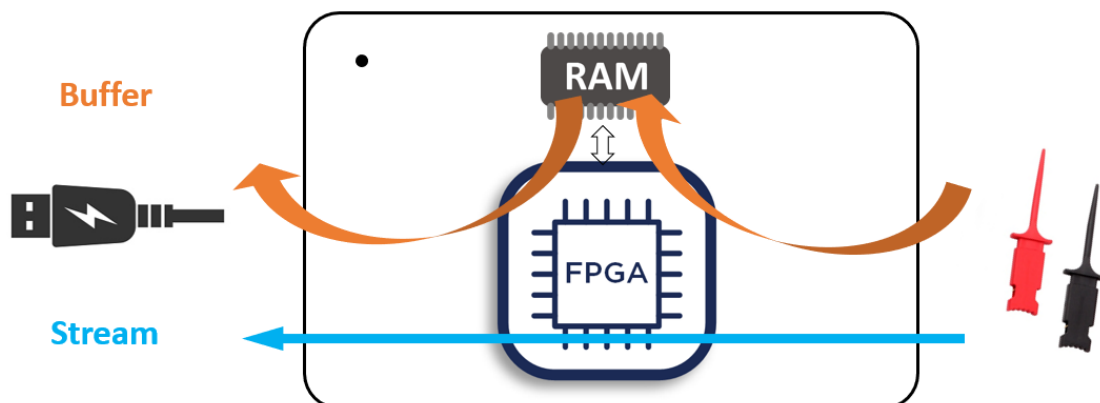

## 5.2 Stop Mode

**Special note:**

1. This function only supports DL32 series devices
2. This function can only be used in Buffer mode.

The logic analyzer supports two stop modes: immediate stop and uploading acquired data. Select under "Configuration" -> "Options" -> "Stop", as shown in the figure below:

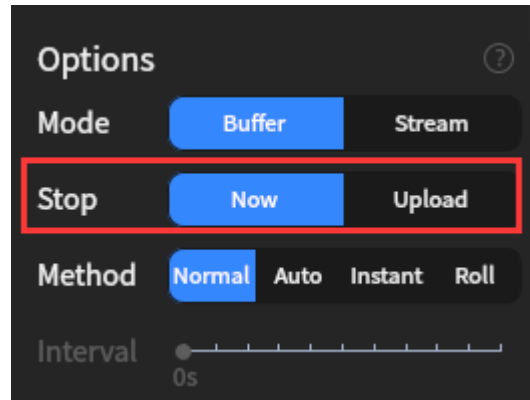

- Stop immediately: Stop acquisition in buffer mode, the acquisition process will be terminated immediately, and no data will be uploaded or displayed.
- Upload acquired data: Stop acquisition in buffer mode, the acquired data in the hardware memory will be uploaded and displayed on the host computer.

## 5.3 Collection method

The logic analyzer supports three different acquisition methods: normal acquisition, loop acquisition and immediate acquisition. Select under "Device Configuration" -> "Options" -> "Method", as shown in the figure below:

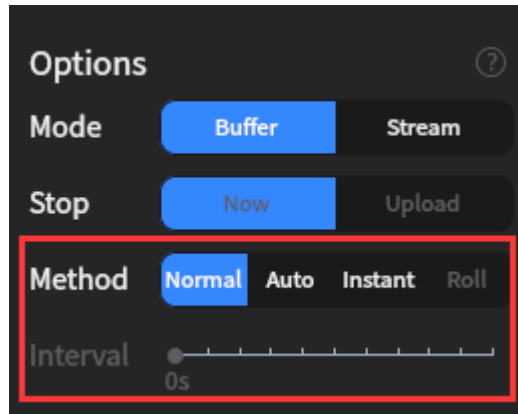

### 5.3.1 Normal

Under normal capture mode, the capture processes for Buffer and Stream modes have some differences. Here are the capture processes for both modes:

- Buffer Mode Capture Process:
  1. **Preparation Phase:**After clicking the 'Start Capture' button, the software sends the set parameters to the logic analyzer.
  2. **Start Capture Phase:**The host computer sends the start capture command, and the logic analyzer begins capturing data.
  3. **Pre-Sampling Phase:**When data collection begins, the logic analyzer enters the pre-sampling phase. It waits until the collected data reaches the pre-sampling depth (trigger position percentage \* sampling depth) before proceeding to the next phase.
  4. **Waiting for Trigger Phase:**If a trigger condition exists, the logic analyzer continues to collect data and overwrites data within the pre-sampling depth until the 'trigger condition matches successfully.' It then exits this phase. If no trigger condition exists, this phase is skipped.
  5. **Waiting for Capture Completion:**When the set sampling time or hardware buffer is full, the logic analyzer terminates the capture process and uploads the collected data to the computer.
  6. **Waveform Rendering Phase:**After data transfer is complete, the software renders the captured waveform data in the display area.
- Stream Mode Capture Process:
  1. **Preparation Phase:**After clicking the 'Start Capture' button, the software sends the set parameters to the logic analyzer.
  2. **Start Capture Phase:**The host computer sends the start capture command, and the logic analyzer begins capturing data.

3. **Pre-Sampling Phase:**When data collection begins, the logic analyzer enters the pre-sampling phase. It waits until the collected data reaches the pre-sampling depth (stream pre-sampling depth cannot be changed) before proceeding to the next phase.
4. **Waiting for Trigger Phase:**If a trigger condition exists, the logic analyzer continues to collect data and overwrites data within the pre-sampling depth until the 'trigger condition matches successfully.' It then exits this phase. If no trigger condition exists, this phase is skipped.
5. **Sampling Phase:**During data collection, the logic analyzer uploads the collected data to the ATK-Logic software in real-time and draws waveform data in real-time. Sampling stops when the set sampling time is reached."

### 5.3.2 Auto

Cyclic capture allows the automatic repetition of the entire normal capture process, with the interval between repetitions determined by the 'Sampling Interval' time. Please note that you can only modify the 'Sampling Interval' time after selecting the 'Cyclic' mode. The countdown time can be viewed on the progress bar near the 'Start Capture' button.

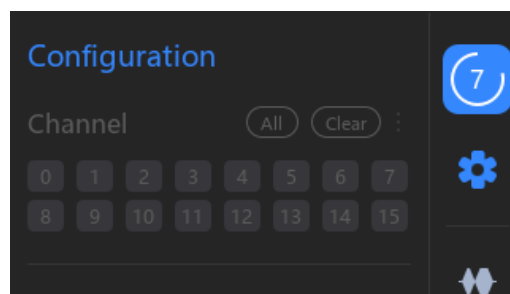
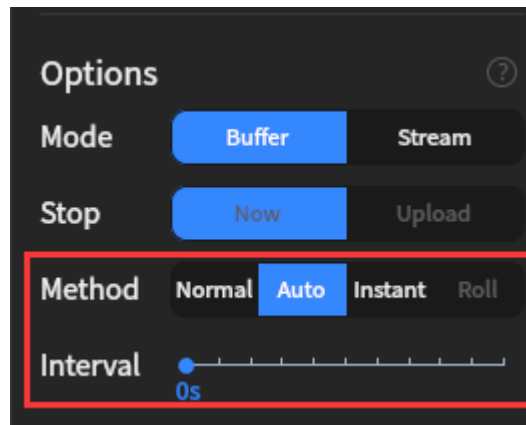

### 5.3.3 Instant

Immediate capture differs from normal capture in that it skips the trigger phase, ignoring all 'trigger conditions.' Other capture processes are the same as in normal capture.

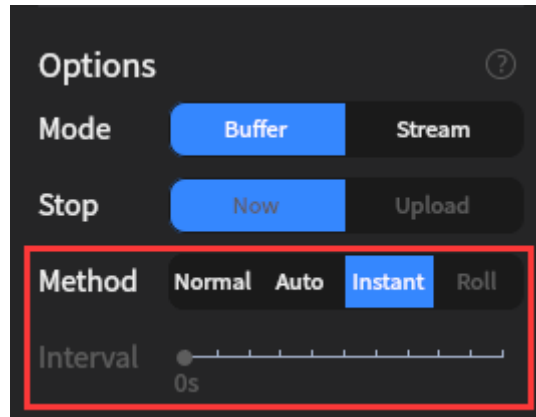

### 5.3.4 Roll

Special note: This function only supports DL32 series devices.

Roll mode is a function that allows real-time continuous display of input signals, usually for low-frequency or slowly changing signals. In roll mode, the waveform rolls from the right to the left of the screen, providing continuous updates of the signal without waiting for a trigger event. This mode can stop acquisition when the required waveform is observed to continue waveform analysis.

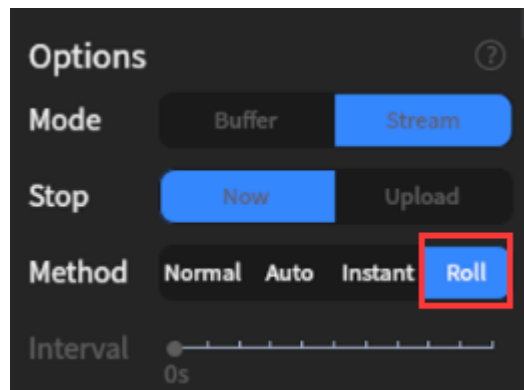

## 5.4 Data Compression

The logic analyzer supports RLE (Run-Length Encoding) hardware data compression algorithm. It is a lossless compression algorithm that replaces consecutive repeated data sequences with a token and the number of repetitions to reduce the size of the data. For example, a waveform data sequence "AAAAABBBCCD" can be compressed with RLE as "5A3B2C1D," where "5A" represents 5 consecutive occurrences of A, "3B" represents 3 consecutive occurrences of B, and so on.

The RLE hardware data compression feature of the logic analyzer is only effective in Buffer mode. This algorithm works best when the tested signal changes slowly or appears intermittently, significantly increasing the sampling depth. However, when the tested signal changes rapidly and continuously, the compression efficiency may be greatly reduced.

In Buffer mode, you can determine whether to enable the data compression feature by using the "Sampling Time" parameter. Time parameters with an asterisk "\*" indicate that this feature is enabled, while parameters without an asterisk indicate that it is not enabled.

**Please note that if you choose a sampling time with an asterisk "\*" (enabling the data compression feature) to capture data, the actual sampling time depends on the amount of variation in the tested signal, and it may not reach the expected value you have set. This is a normal behavior.**

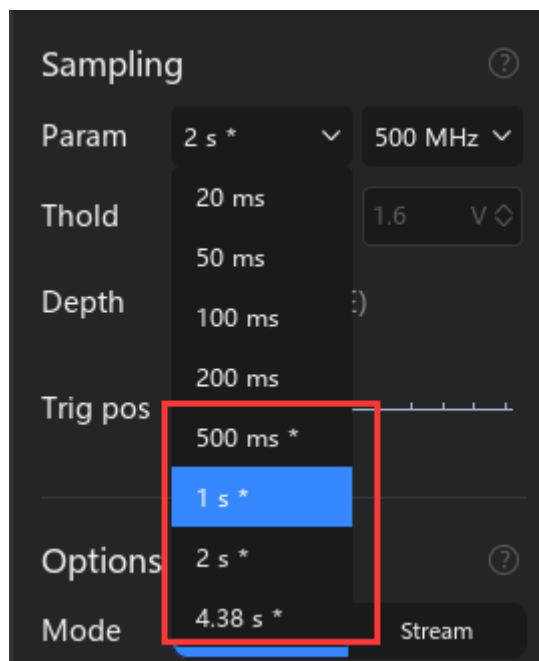

## 5.5 Channel Selection

Logic analyzers generally support many channels, and the maximum sampling rate corresponding to the number of channels will be different. In fact, in many cases, we may only use a few of the channels. ATK-Logic software provides the function of individually enabling and disabling a single channel, and you can enable or disable the channel under "Device Configuration" -> "Channel".

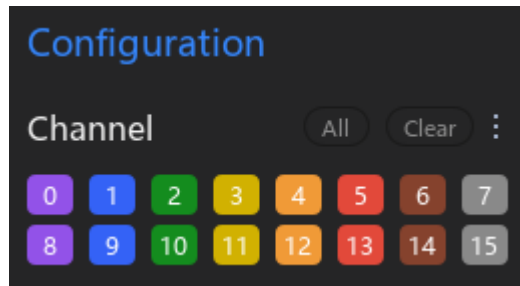

Among them: "All" opens all channels, "Clear" only retains channel 0, and also provides a quick opening function in the more options in the upper right corner.

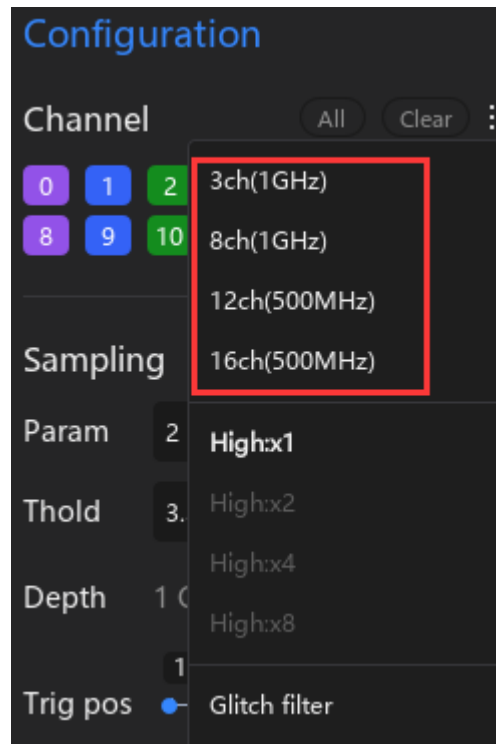

## 5.6 Sampling Time

The sampling time can be set to determine the time over which samples will be collected. It's essential to make an approximate evaluation of the tested signal before setting the sampling time. More extended sampling times are not necessarily better, as longer times result in longer waiting periods. The choice of an appropriate sampling time should be based on factors such as the frequency of the tested signal, waveform characteristics, and the required analysis accuracy. Different operating modes, sampling rates, and the number of channels can also influence the optimal sampling time.

**Please note that if the sampling time has an asterisk "\*" next to it, it indicates the use of the data compression feature in Buffer mode. For more details, please refer to the "Data Compression" section.**

You can select the sampling time from the "Device Configuration" -> "Sampling" -> "Param" -> "Time" dropdown menu.

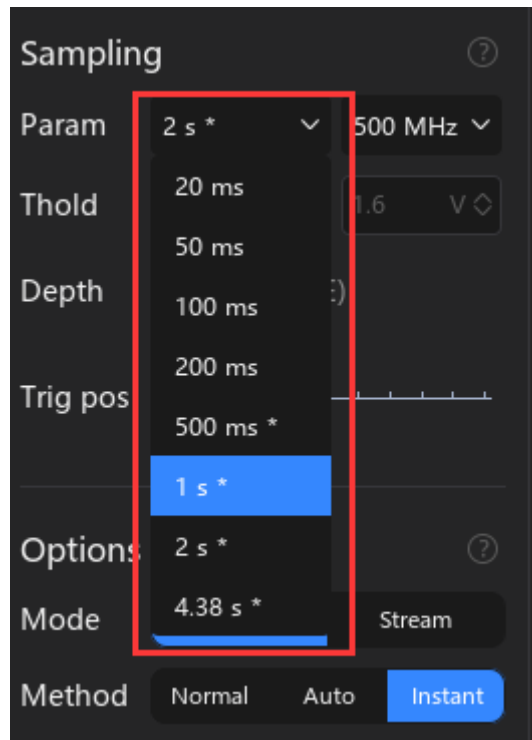

## 5.7 Sampling frequency

Sampling frequency, also known as the sampling rate or sample rate, refers to how many signal samples can be collected within one unit of time. A higher sampling frequency allows for better waveform reproduction but also results in larger data volumes. Conversely, a lower sampling frequency may lead to waveform distortion and reduced data volume. It's important to note that a higher sampling frequency is not always better. A recommended practice is to set the sampling frequency to be at least 10 times the frequency of the tested signal.

The sampling period is the time required to complete one full sampling cycle and can be calculated as the reciprocal of the sampling frequency, i.e.,  $\text{sampling period} = 1 / \text{sampling frequency}$ . For example, in a system with a sampling frequency of 1 MHz, the sampling period is 1 microsecond ( $\mu\text{s}$ ).

The maximum sampling frequency of a logic analyzer depends on the operating mode and the number of channels in use. You can check the supported maximum sampling rates for the current mode and channel count in the "Device Configuration" -> "Channel Selection" -> "More" section.

When using a logic analyzer in practice, it is essential to choose the most appropriate sampling frequency based on the frequency of the signal being measured to achieve the best performance. You can configure the sampling frequency from the drop-down menu under "Device Configuration" -> "Sampling" -> "Frequency," as shown below.

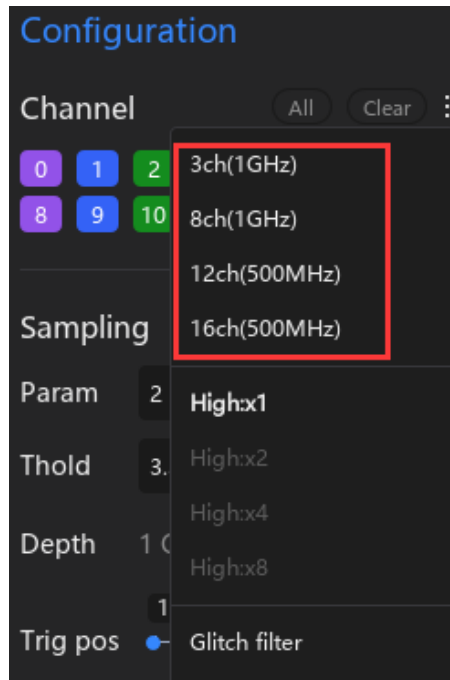

## 5.8 Sampling Depth

A logic analyzer stores the collected "logic 0" and "logic 1" waveform information in its memory, and the capacity of this memory is referred to as the sampling depth. It is evident that the greater the sampling depth, the more waveform data can be collected. The amount of data collected in each sampling is determined by the sampling time, sampling frequency, and the number of channels, and its calculation formula is as follows:

$$\text{Depth (unit: bit)} = \text{time (unit: s)} * \text{frequency (unit: hz)} * \text{ch}$$

In actual usage, the ATK-Logic software automatically calculates it for us. You can check the current sampling depth by going to "Device Configuration" -> "Sampling" -> "Depth," as shown in the figure below. The method for calculating sampling depth is as follows: 250MHz \* 1s \* 1ch = 250M.



## 5.9 Trigger Threshold

A logic analyzer differs from an oscilloscope in that it can only capture digital signals. It determines the measured signal by comparing it using a comparator: signals above a reference voltage are considered "logic 1," while those below are considered "logic 0," creating a digital waveform between consecutive 1s and 0s. This "reference voltage" is the trigger threshold, and it serves as the standard for determining high and low levels in the digital signal. It is recommended to set the threshold voltage at 0.5 times the voltage level of the measured signal for optimal sampling performance, as calculated in the figure below. The threshold voltage setting must be correct, or else the captured waveform may be incorrect. You can set the threshold voltage from "Device Configuration" -> "Sampling" -> "Trigger Threshold."

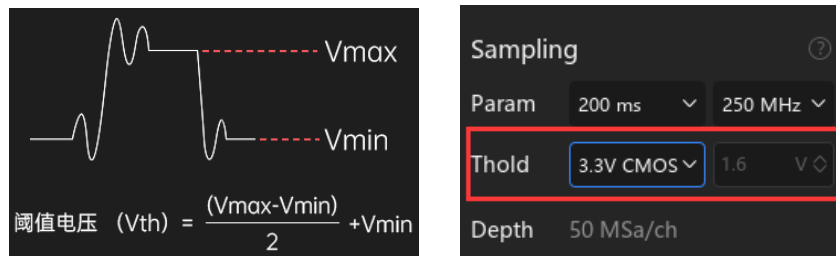

## 5.10 Trigger Position

The trigger position can be adjusted to specify the point within the entire sampling time at which the triggering event occurs. This adjustment makes it convenient to observe waveform data before and after the trigger point. If you wish to examine the data before the trigger point, you can modify the trigger position value accordingly to ensure that the signal being tested is fully captured. You can set the trigger position by navigating to "Configuration" -> "Sampling" -> "Trigger Position," as illustrated in the following diagram.

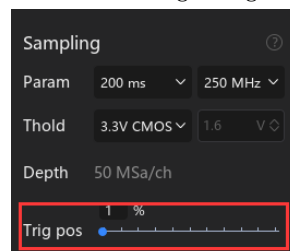



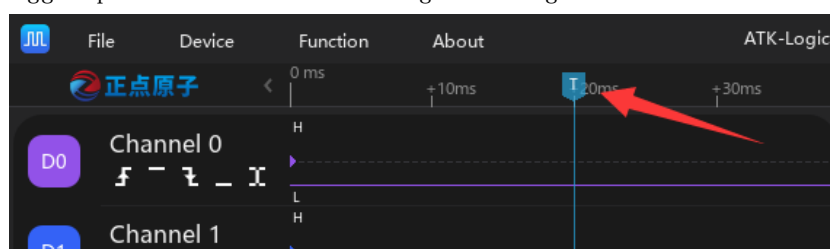

The trigger position is marked using the "Tag T."



## 5.11 Simple Trigger

The trigger in a logic analyzer involves setting the acquisition conditions. Data collection begins only when the measured signal meets these conditions; otherwise, it remains in a waiting-for-trigger phase. The conditions that dictate when data collection starts are known as trigger conditions. In most cases, the measured signal is not continuously present, and if you want to observe a specific moment in the signal, you must use the trigger functionality. For example, in UART serial communication protocols, when the signal line is idle, it is at a high logic level, and the start of a signal is marked by a transition from a high level to a low level. In this case, the trigger condition should be set to "falling edge" to capture the data when the signal transitions from high to low.

Simple triggering of the logic analyzer can be set from the "Channel Options" on the left side of the ATK-Logic software. From left to right, these options are:

 rising edge trigger,  high-level trigger,  falling edge trigger,  low-level trigger, and  edge trigger.



The logic analyzer not only supports setting trigger conditions for individual channels but also allows you to freely combine trigger conditions for multiple channels using a "logical AND" relationship. In other words, data collection will only begin when all channels' trigger conditions are simultaneously met. This flexible approach to logical AND combinations is very versatile. For example, if you want to observe when the 8-bit parallel data line contains the value 0xA5 as the trigger condition, you can configure it as shown in the diagram below:

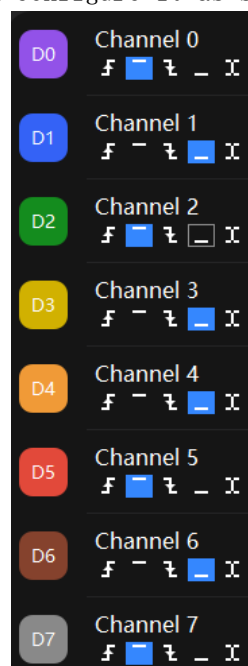

## 5.12 Advanced Trigger

**Special note: This function only supports DL32 series devices.**

In addition to simple triggering, the logic analyzer also provides advanced triggering. The advanced triggering function provides a standard trigger template, which can set the "appropriate trigger logic" according to the measured signal to complete the triggering of "specific data". Advanced triggering currently supports two sets of templates: parallel triggering and serial triggering.

If you want to use the advanced triggering function, turn on the switch button under the "Advanced Triggering" page, as shown in the figure below.

**Note: Only one of the advanced triggering and simple triggering can be used at the same time. After turning on the advanced triggering function, the simple triggering function is disabled by default.**

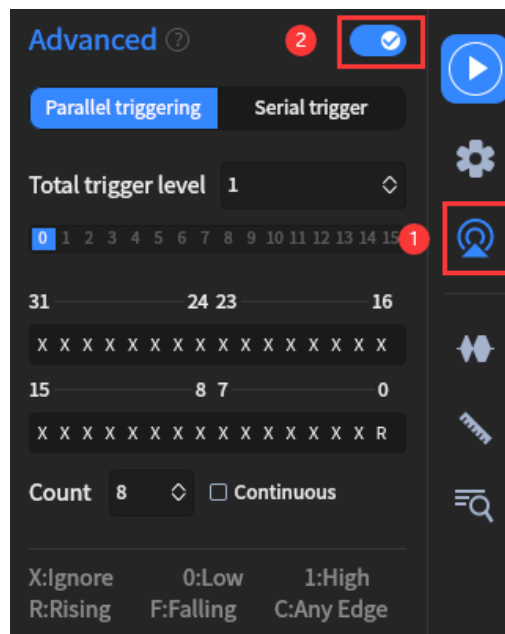

### 5.12.1 Parallel triggering

Parallel triggering has designed a trigger template for parallel buses, which can specify specific parallel protocol data as trigger conditions and support up to 16 levels of trigger conditions. Parallel triggering starts with matching the 0th level condition, and then matches the next level condition after the condition is met, until each level condition is matched successfully in sequence before triggering. If there is a mismatch, it will continue to search for trigger conditions in the current level event unless it is terminated manually.

The basic steps for using parallel triggering are as follows:

- 1) Turn on advanced functions
- 2) Select the parallel trigger function
- 3) Select the trigger level
- 4) Set the trigger conditions for each level

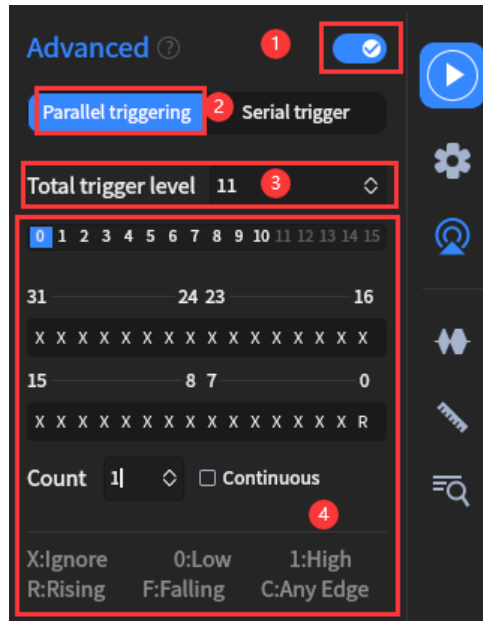

The total number of trigger levels is set in the third column. In the example above, the total number of trigger levels is 11. The fourth column is the trigger condition of each level. The specific trigger level can be selected through the top bar. In the example above, it is level 0. The trigger conditions of each level include: trigger conditions of each channel, counting and continuous functions.

The trigger conditions of each channel can be set to: X: Don't care, 0: low level, 1 high level, R rising edge, F: falling edge, C: Any edge.

The counting function is the accumulation of channel trigger conditions. When the set "count value" is reached, the current level has met the trigger conditions and will enter the next level of trigger condition judgment.

The continuous function is a supplement to the counting function. The continuous function is to ensure that the signal "cannot change within a period of time (mainly the high and low levels cannot jump)". If the continuous function is not enabled, the counting function is only responsible for recording the number of times the channel trigger condition is met. When the condition is met, it is accumulated once, such as the pulse counting scenario. If the continuous function is enabled, the counter will determine whether the channel trigger condition "lasts for a period of time" (within the set count value, the signal cannot change). If the signal jumps, the counter will reset to zero and start counting again.

**Note: The continuous function is only valid for continuous counting of high and low levels.**

The following is an example of multi-level triggering:

- Channel 0 generates 10 rising edges and then triggers (1st level, counting, discontinuous)

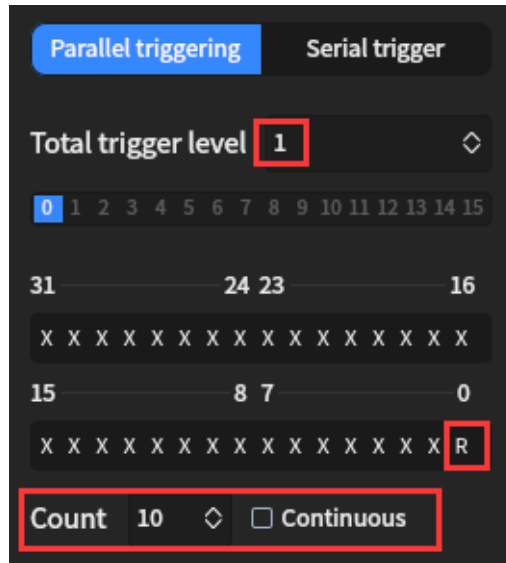

- Channel 0 continues high for 100 sampling cycles (level 1, counting, continuous)

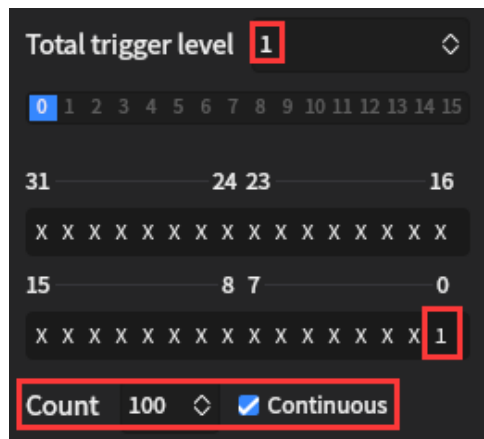

- After channel 0 generates a falling edge, channel 1 continues to maintain a low level for 100 sampling cycles, and finally channel 2 generates 100 rising edges to trigger (3 levels)

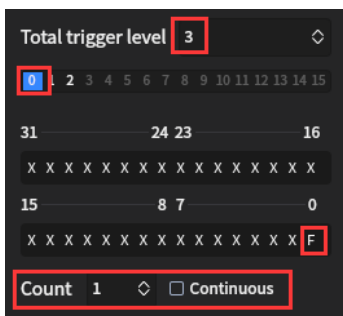

Level 1

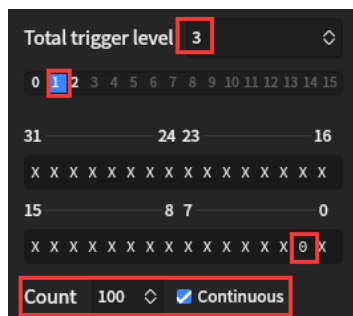

Level 2

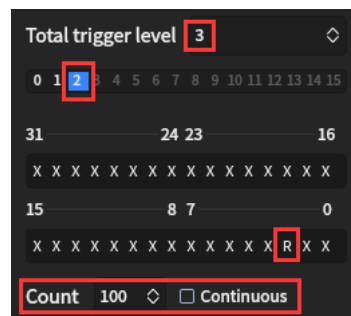

Level 3

### 5.12.2 Serial trigger

Serial triggering has designed a trigger template for serial buses, which can specify specific serial protocol data as trigger conditions. The logic of serial triggering is that when the "start condition" is met, the value of the "data bit width" and "data channel" is sampled under the set clock condition. If this value is equal to the set "data value", it will trigger immediately. If the "stop condition" is matched in advance, the current matching data will be reset, and the data value for matching will be re-formed after the next "start condition" is met.

The basic steps for using serial triggering are as follows:

- 1) Open advanced functions
- 2) Select serial triggering function
- 3) Select trigger level
- 4) Set start trigger conditions
- 5) Set end conditions
- 6) Set clock conditions
- 7) Set data conditions

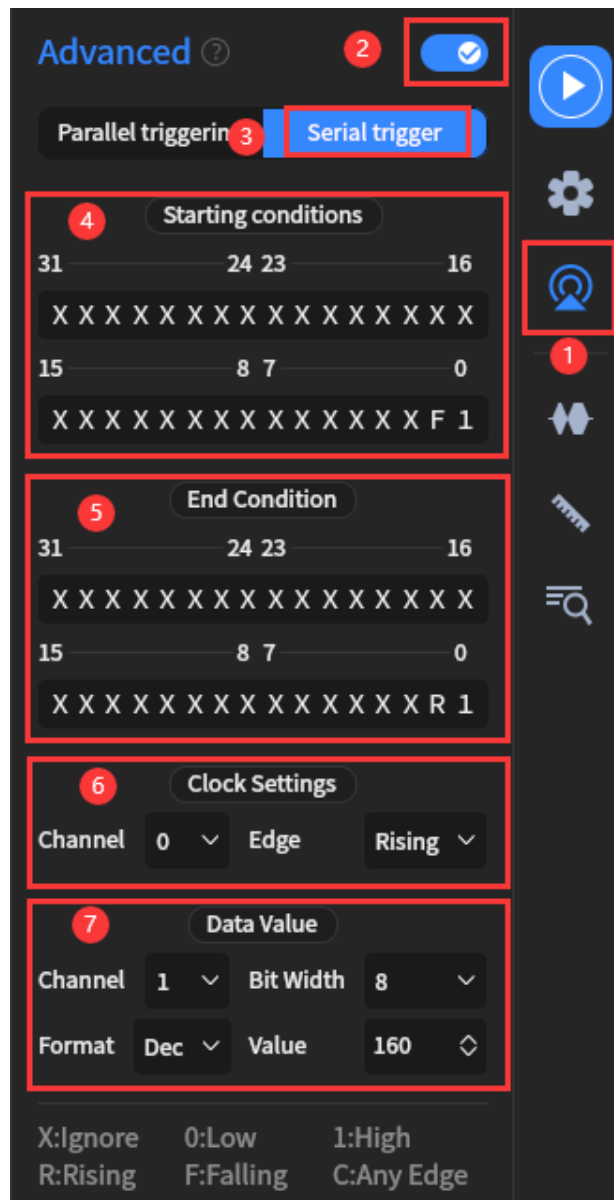

Taking the IIC protocol as an example, the IIC protocol is described as follows:

- IIC start condition: When SCL is high, the falling edge of SDA
- IIC end condition: When SCL is high, the rising edge of SDA
- IIC data stability condition: When SCL is high, SDA must remain stable, that is, the rising edge of SCL

According to the above protocol agreement, if you want to trigger a specific value in the IIC protocol: hexadecimal 0xA0 (decimal 160), the serial trigger setting example is as follows:

- Start condition: Channel 0 (SCL) is set to 1 high level, channel 1 (SDA) is set to falling edge
- End condition: Channel 0 (SCL) is set to 1 high level, channel 1 (SDA) is set to rising and falling edge
- Clock setting: Clock channel is channel 0 (SCL), condition is rising edge
- Data value: Data channel is channel 1 (SDA), bit width is 8 bits, data value is 160 (decimal)

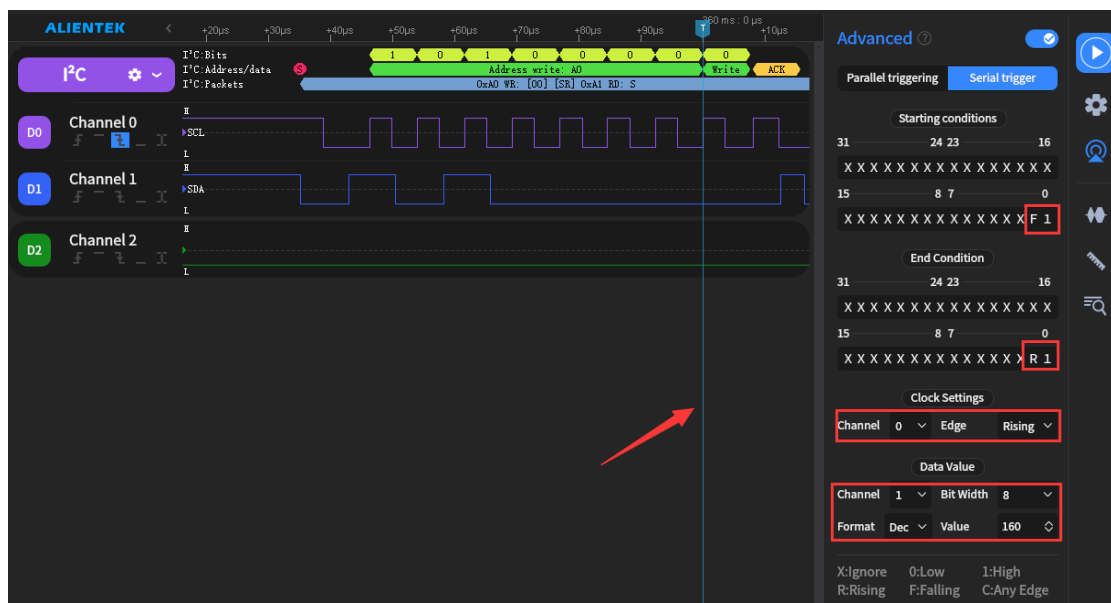

## 5.13 Glitch filter

In the previous section "3.1 " we have provided you with a variety of wiring methods to avoid burr problems as much as possible, but the actual situation may not be ideal. ATK-Logic software provides software filtering methods for Everyone chooses.

The glitch filtering function can be turned on in "Device Configuration"->"Channel"->"More"->"Glitch Filtering Settings".

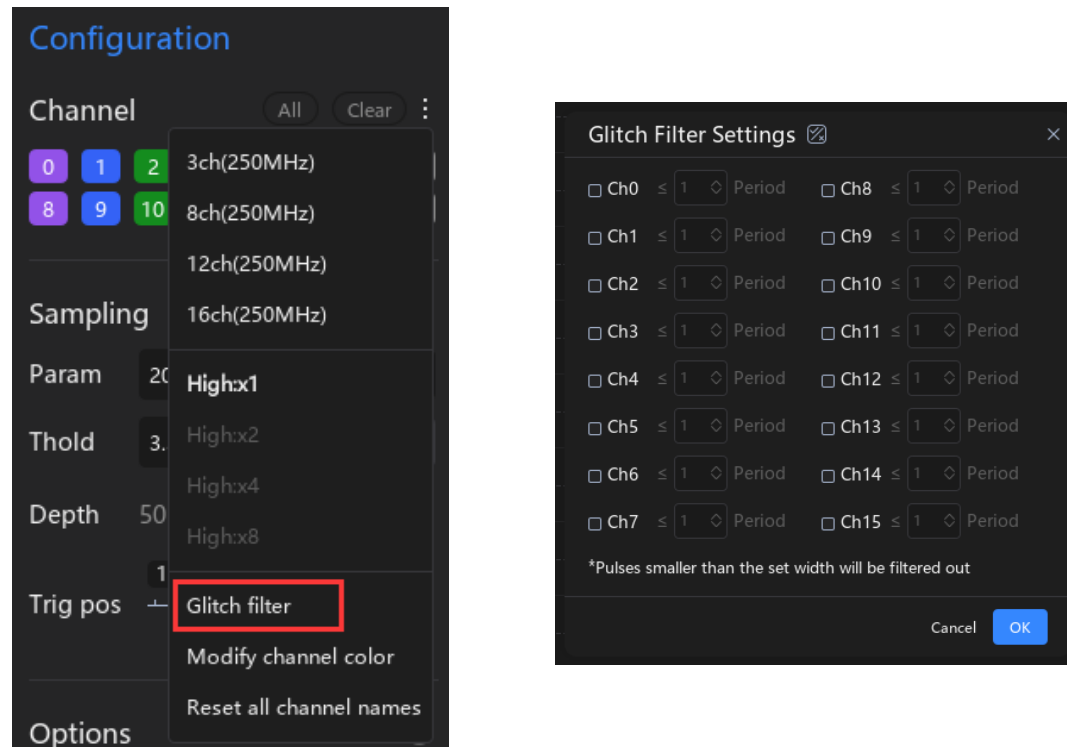

The spike filtering function of a logic analyzer is achieved by setting a pulse width, where waveform data with a pulse width shorter than the specified value is considered as spike signals and filtered out. As indicated in the diagram, ATK-Logic software determines this based on the sampling period. If you wish to apply filtering to a specific channel, you can do so by first selecting the channel and then configuring the filtering period.

The calculation formula for filter pulse width is as follows:

Filter pulse width = Custom N value \* Current sampling period

Where:

Filter pulse width: pulse width to be filtered

Custom N value: Custom filter values

Current sampling period: 1s/current sampling rate

For example:

The current sampling period is 1GHz, and we need to filter out pulses of 10ns and below. The calculation is as follows:

$$\begin{aligned} \text{Custom N value} &= \text{Filter pulse width (10ns)} / \text{Current sampling period (1ns=1s/1Ghz)} \\ &= 10 \end{aligned}$$

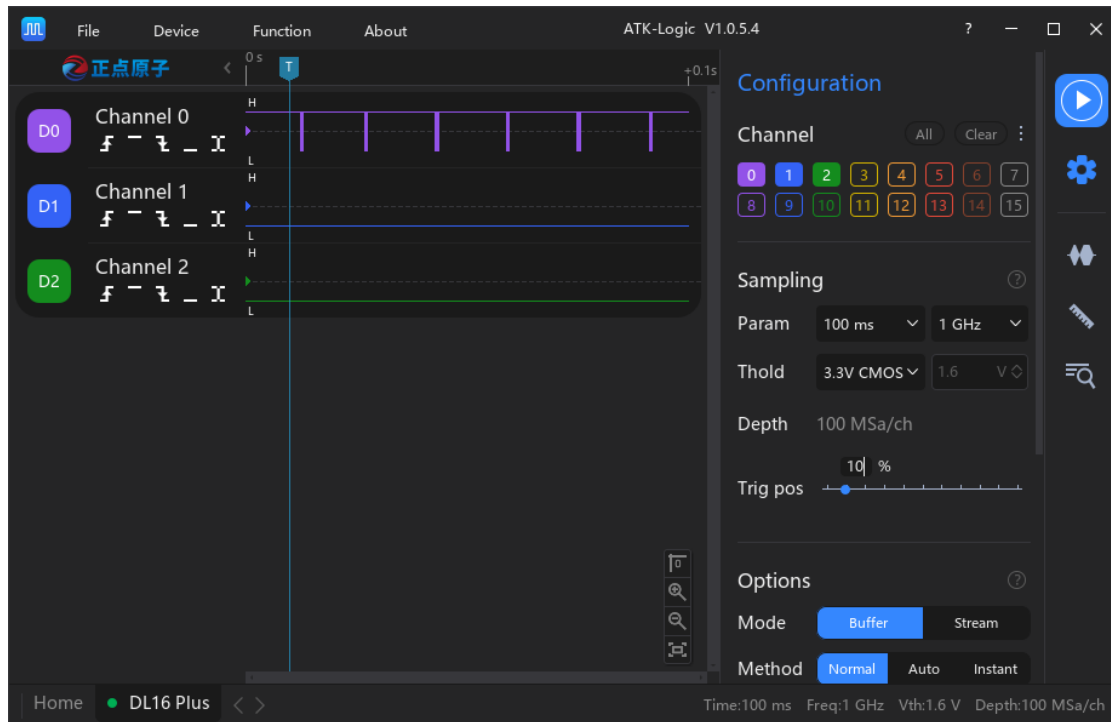

## 5.14 Waveform viewing

After the data collection is completed, the captured signal waveform will be rendered to the display area by the software, as shown in the figure below (example of collecting UART data)



It is evident that without zooming and dragging operations, it's impossible to clearly observe the waveforms. To assist us in better visualizing waveform data, ATK-Logic software offers several convenient operations, including:

- **Waveform Zoom:** You can use the mouse scroll wheel (middle button) to zoom in on the waveform by scrolling up and zoom out by scrolling down.
- **Waveform Drag:**
  1. You can click and hold the left mouse button to drag the waveform left or right.
  2. In the "Waveform Display Area," you can use Alt + mouse scroll wheel (middle button) to quickly scroll the data left or right. Continuous scrolling in one direction will continue to scroll the data.
- **Region Zoom:** You can click and hold the right mouse button while moving the mouse to create a rectangular area. Release the right mouse button to zoom in on the selected rectangular area.
- **Channel Scrolling:**
  1. Place the mouse cursor in the left-hand "Channel Options Area," and use the mouse scroll wheel (middle button) to scroll the channels up and down.
  2. In the "Waveform Display Area," you can use Ctrl + mouse scroll wheel (middle button) to quickly scroll the channels up and down.
- **Quick Zero Crossing Jump:** You can click on the right-bottom corner of the waveform display area to quickly jump to the zero crossing point.

- **Quickly zoom to full screen:** Click with the mouse  (in the bottom-right corner of the waveform display area).
- **Quick Zoom Buttons:** Zoom In Button , Zoom Out Button  (located in the lower right corner of the waveform display area)
- **Channel Height Adjustment:**
  1. Place the mouse cursor on the channel divider in the "Channel Options Area", press and hold the left mouse button, then drag it up or down to freely adjust the channel height.
  2. In "Device Configuration" -> "Channel Selection" -> "More", there are shortcuts for x1/x2/x4/x8 preset settings.
- **Channel Order Adjustment:** In the "Channel Options Area", left-click and hold the channel ID (e. g. , D0), then drag it up or down to adjust the channel arrangement order.
- **Channel Name Editing:** Left-click on the channel name to select it, then you can modify it.
- **Collapse Channel Options:** Click with the mouse (next to the top left corner near the Positive Atom logo).

## 5.15 Waveform Measurement

### 5.15.1 Mouse Measurement

Mouse measurement function can be enabled/disabled in the "Settings" -> "General" interface. After data acquisition, simply place the mouse cursor on the waveform, and it will display the current pulse's width, period, frequency, and duty cycle data. The measurement result is shown in the following image:

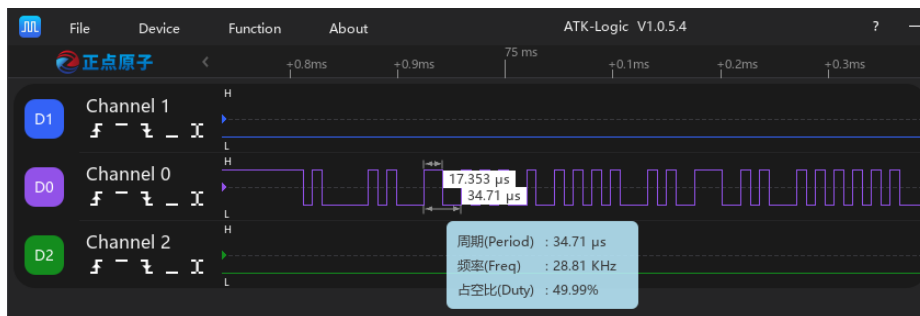

### 5.15.2 Cross-Channel Measurement

After left-clicking on a data edge with the mouse, you can measure the time duration from the cursor to the starting point as well as the frequency. During cross-channel measurement, you can freely zoom in or out of the data. The effect is shown in the following image:

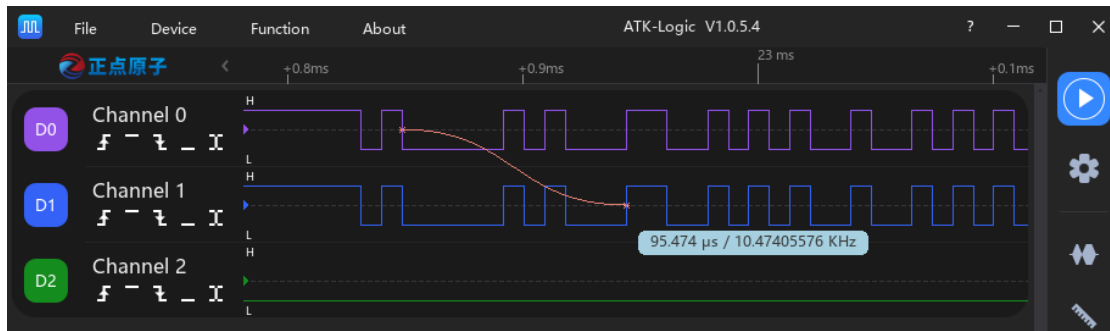

### 5.15.3 Label Measurement

There are two ways to insert time labels:

1. Place the mouse cursor on the time axis and double-click the left mouse button to insert a new time label.
2. Choose 'Add Label' from 'Label Measurement' -> 'Time Labels' -> 'More.' Move the mouse to the waveform.

After adding a time label, move the mouse cursor to the label, and a single left-click can select it. At this point, the label can be moved left or right along with the mouse, and if you move the mouse to a waveform transition edge, it can automatically snap to the edge. Double-clicking it from the time label list allows for quick navigation. You can also change its color and add annotations.

Additionally, you can measure the time between two labels, as shown in the following image:

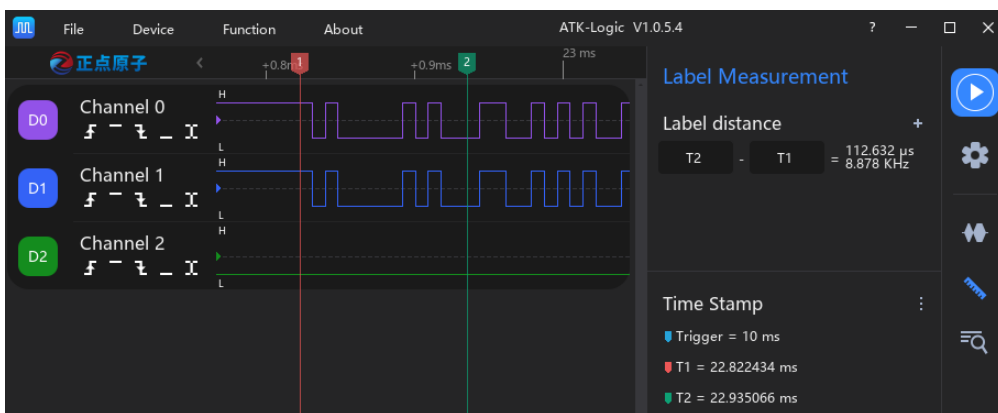

### 5.15.4 Parameter Measurement

Parameter Measurement function provides more detailed data, including interval time, start time, end time, minimum frequency, maximum frequency, rising edge count, and falling edge count parameters.

Parameter Measurement function can be inserted as follows: Go to 'Label Measurement' -> 'Parameter Measurement' -> 'More.' Move the mouse cursor to the waveform display area, press and hold the left mouse button, then drag the mouse left or right to select the waveform you want to measure. Release the left mouse button to insert the Parameter Measurement label (you can also use shortcut keys for this). It supports features such as color modification, adding annotations, copying data, and setting the label to be on top, as shown in the following image:

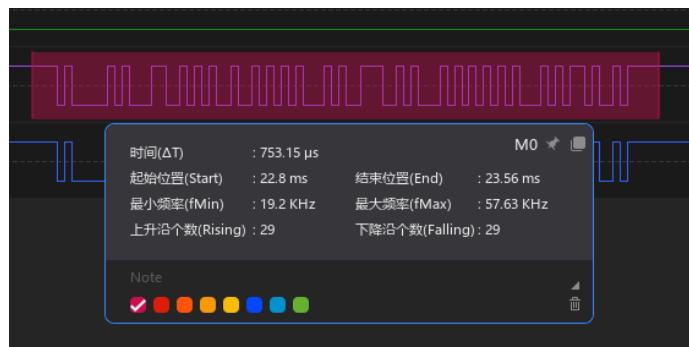

## 5.16 Protocol Decoding

### 5.16.1 Add Protocol

From the right-side toolbar, click on  'Protocol Decoding' -> 'Protocol'. This will list the currently supported protocols. Hover the mouse over a protocol to view its description, and click on the protocol name to enter the protocol configuration interface, as shown in the following image.

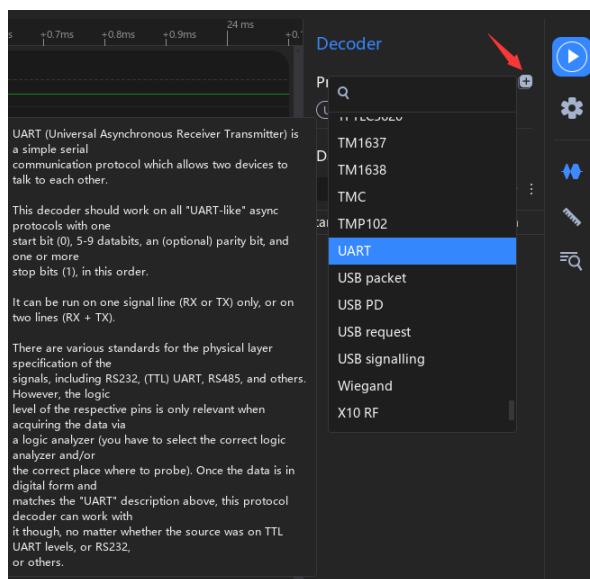

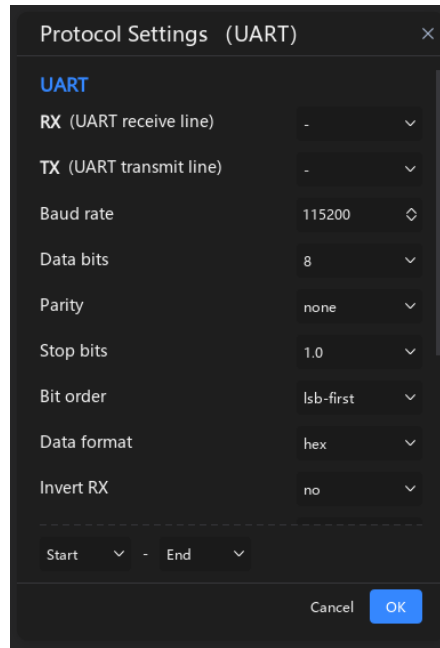

In the 'Protocol Settings' window, configure the parameters and click 'Confirm' to add a new protocol. The newly added protocol can be viewed in the 'Waveform Display Area' and under 'Protocol Decoding' -> 'Protocols' list, as shown in the following image.

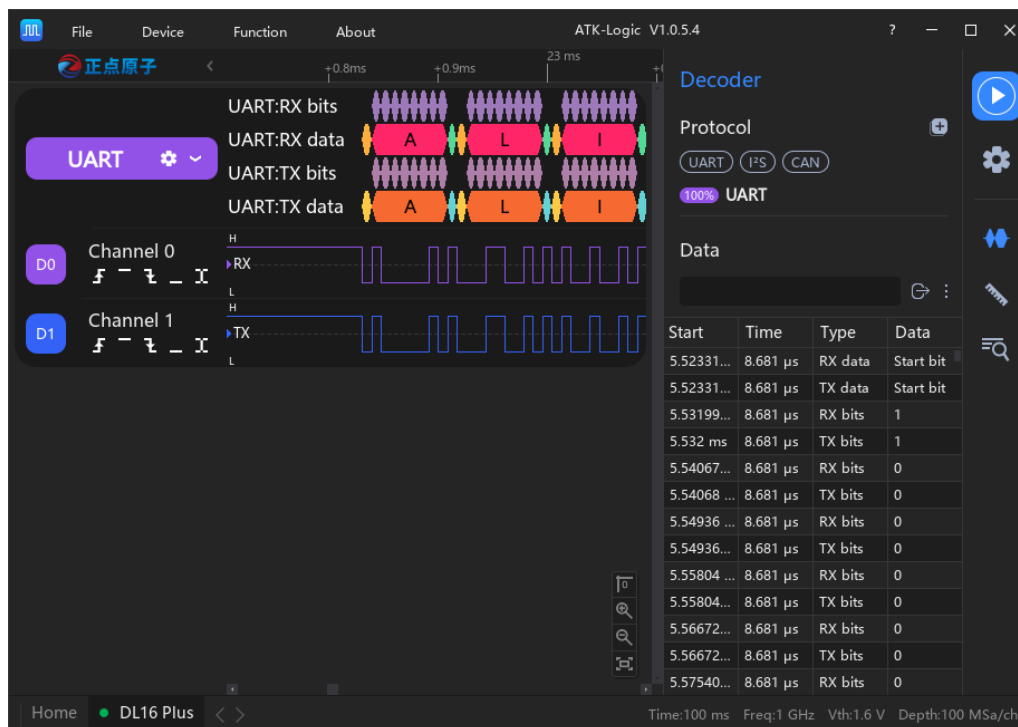



As seen in the image above, decoded data is displayed along with the waveform and is also presented in a list format in the 'Data Interface'.

ATK-Logic software provides several small features for the convenience of observing important information and maintaining a clean interface:

- Specifying Decoding Region: In the 'Protocol Settings' interface, at the bottom, you can specify the decoding data region by setting 'Start' and

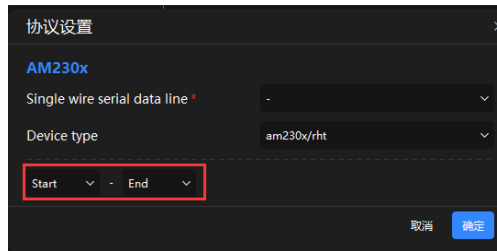
‘End’ time labels to save decoding time.



- Waveform Data Filtering: Click the  ‘Protocol Settings’ button from the left-hand ‘Channel Options’. In the ‘Show’, only select the decoded data you want to display to simplify the waveform interface.

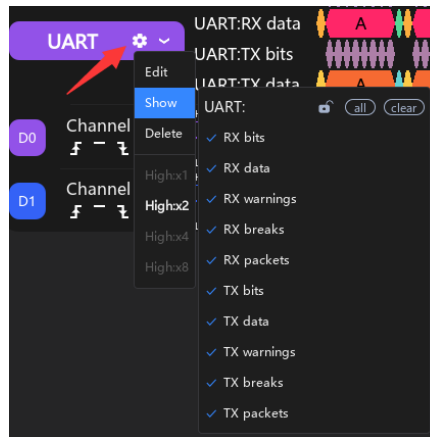

- Protocol Row Display Lock: By default, the protocol rows adapt to display the protocol data, and if there is no protocol in the waveform area, the protocol rows are automatically hidden. However, if you choose to lock the protocol row position, the protocol rows will be displayed even if there is no protocol in the waveform area.

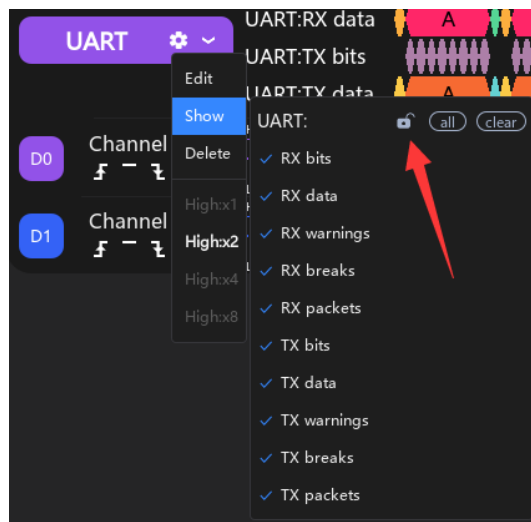

- Displaying Decoded Result Lists: When adding multiple protocols simultaneously, the decoded data may not be shown in the same list. You can select which protocols to display from ‘Protocol Decoding’ -> ‘Data’ -> ‘More’.

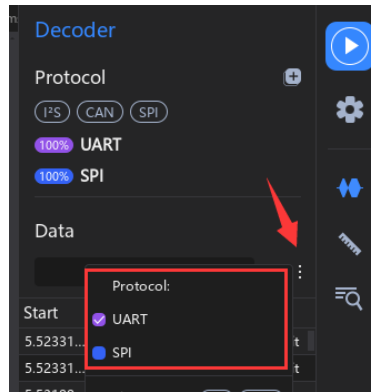

- Decoded Result Data Filtering: Decoded results are displayed by default with all information from the current protocol. You can simplify the list data by selecting the data you want to display from ‘Protocol Decoding’ → ‘Data’ → ‘More’ → ‘Display Rows’

**Helpful Tip: Double-clicking data in the list allows for quick navigation to the waveform.**

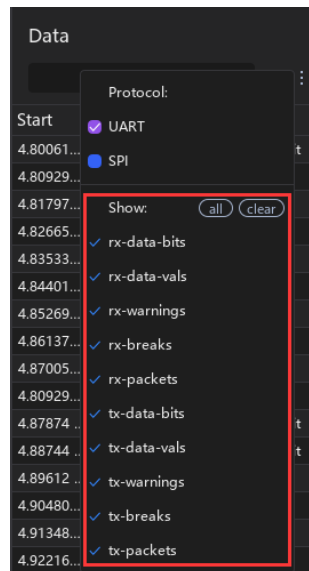







- Decoding result data search: Enter the content to be searched in the input box, it is not case sensitive, supports content search by type and data column, and supports advanced syntax search.

Start	Time	Type	Data
4.80061...	8.682 μs	RX data	Start bit
4.88744 ...	8.682 μs	RX data	Start bit
4.97428 ...	8.682 μs	RX data	Start bit
5.06112 ...	8.682 μs	RX data	Start bit
5.14793...	8.682 μs	RX data	Start bit
5.23474 ...	8.682 μs	RX data	Start bit
5.32155...	8.682 μs	RX data	Start bit
5.40839...	8.682 μs	RX data	Start bit
17.5250...	8.682 μs	RX data	Start bit
17.6118...	8.682 μs	RX data	Start bit
17.6985...	8.682 μs	RX data	Start bit
17.7853...	8.682 μs	RX data	Start bit
17.8721...	8.682 μs	RX data	Start bit

- D Advanced syntax search  
Supported symbols: !, &&  
Explanation: ! is not equal to a certain data, && parallel conditions  
For example: you need to search for text data that contains "alientek"  
but does not contain "stop"  
Expression: alientek&&!stop  
**NOTE: Sensitive to symbols and spaces**

### 5.16.2 Tips and Small Features

- **Customizing Protocol Decoding Display Results:** Select 'Protocol Settings'  -> 'Show' and check the results you want to display.
- **Protocol List Decoded Data Filtering:** Choose 'Protocol Decoding'  -> 'Data Filtering' , and check the data you want to filter.
- **Exporting Protocol Decoded Data:** Select 'Protocol Decoding'  -> 'Export Table'  to export the current table data. **(Handy Tip: This feature can be used in conjunction with the data filtering feature.)**
- **View following function:** Select 'Protocol Decoding'  -> 'View following' , That is, the corresponding list data can be scrolled synchronously when scrolling the view interface.

### 5.16.3 Protocol Settings Explanation

ATK-Logic supports over 170 protocols. To help users quickly understand various protocol configuration parameters, you can access the online documentation to find relevant information.

Online Documentation: <http://www.openedv.com/ATK-Prod/ATK-Logic/docs/index.html>

The online documentation will continue to be updated.....

#### 5.16.4 Custom Protocol Development (Secondary Development)

Although the software supports over 170 commonly used protocol decoders, it may still not meet the specific needs of some users. For this reason, we have prepared a document that guides you on how to add your desired protocols. You can access the online documentation for detailed instructions:

Online Documentation: <http://www.openedv.com/ATK-Prod/ATK-Logic/docs/index.html>

The online documentation will continue to be updated.....

#### 5.16.5 Protocol Debugging

ATK-Logic software provides custom protocol debugging functionality. To access it, open 'Function' -> 'Settings' from the top-left toolbar, and select 'Decoder'. The specific debugging process is as follows:"

- Open the settings interface and change the debugging level to 'Spew' .

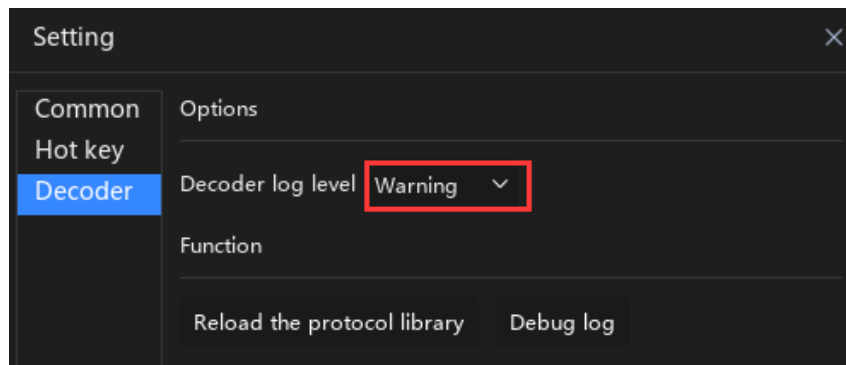

- Open the 'Debug Log' Window.

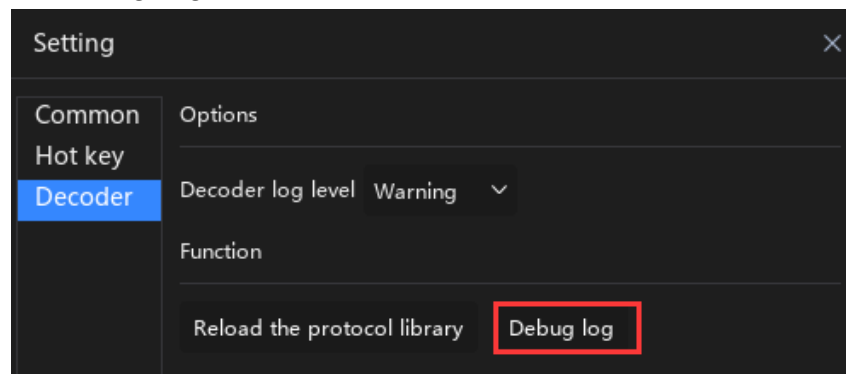

- After creating or modifying a protocol, click on 'Reload Protocol Library' . Check the log for any error messages, as shown below:

Note: If you have modified protocol parameters, display rows, or other content, you may need to delete the protocol and re-add it. Direct re-parsing may not apply the changes.

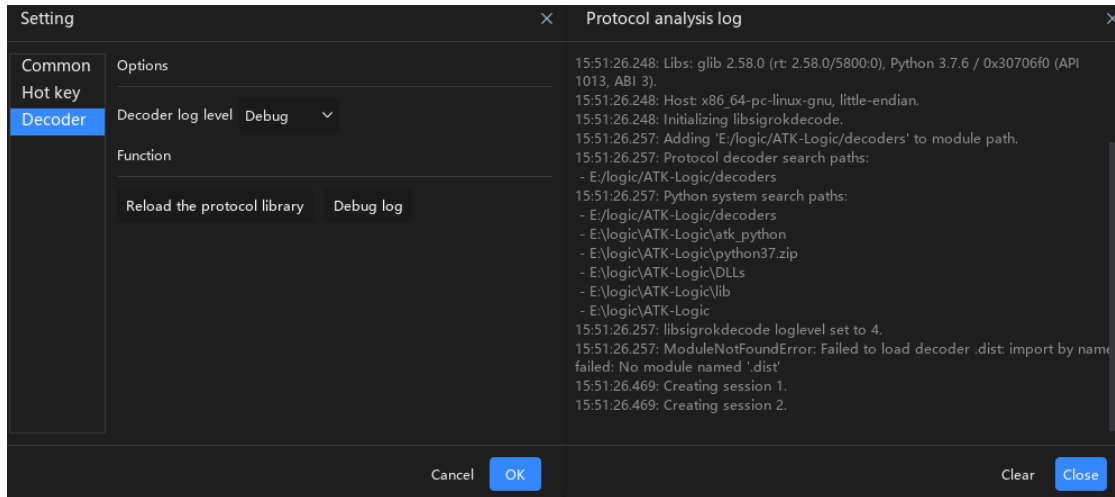

## 5.17 Data Search

Data Search functionality allows you to set search criteria to find waveform points that meet specific conditions within your collected sample data. It helps you quickly locate waveforms of particular signals.

To open the Data Search feature, you can do so from the right-side toolbar. The search conditions can be set as follows: Don't Care, Low Level, High Level, Rising Edge, Falling Edge, and All Edges. You can also specify the search area using time labels, determined by Start and End.

For example, if you want to search for all waveforms where Channel 0 has a falling edge and Channel 1 has a low level, you can configure it as shown in the image below, and the search results will be displayed as shown in the following example:

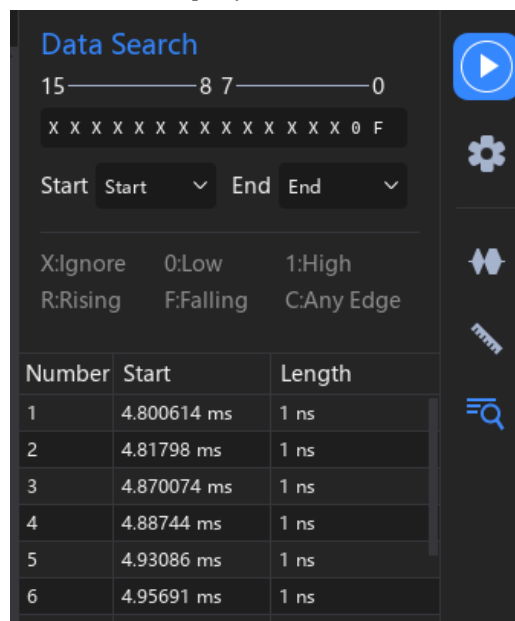



## 5.18 PWM Output

The logic analyzer also supports waveform output functionality. To access it,

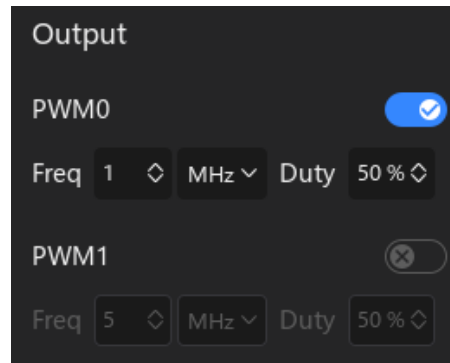
open the ‘Device Configuration’ in the right-side toolbar, and in the lower right corner, you can find ‘Waveform Output’. This interface is only available when the software is connected to a device that supports PWM output. By default, the device has PWM functionality disabled. The detailed parameter settings interface is as follows:”



The following:  is for enabled status,  is for disabled status.

## 5.19 Channel Color

ATK-Logic software defaults the channel color to match the color of the corresponding channel connection line. If you don’t like the default color, you can open the ‘Channel Color Modification’ interface from ‘Device Configuration’ -> ‘Channel’ -> ‘More’ to change the channel color. It is shown in the image below:

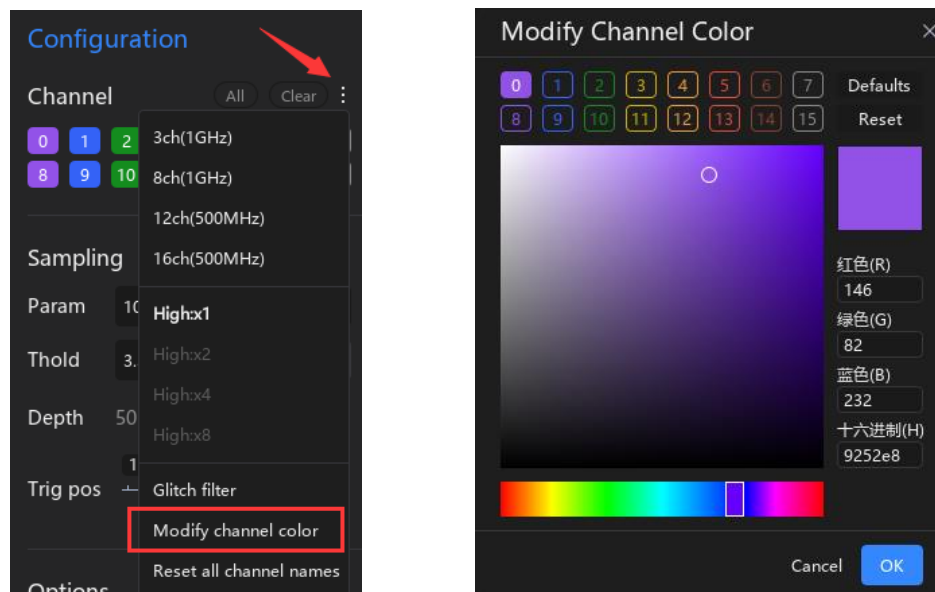

## 5.20 File Saving

ATK-Logic software supports two types of data-saving functions: project files and waveform data.

Function:

- **Project Saving:** Open the ‘File’ option from the top-left toolbar, and choose

‘Save’ or ‘Save As’ to save the project file.

- **Opening a Project:** Open the ‘File’ option from the top-left toolbar, click ‘Open,’ and select a file with the ‘.atkdl’ extension to open a previously saved project.
- **Importing a Project:** Open the ‘File’ option from the top-left toolbar, click ‘Import Project,’ and select a file with the ‘.atkdl’ extension to import project parameters into the currently connected device page. (Importing a project requires connecting to a device first.)

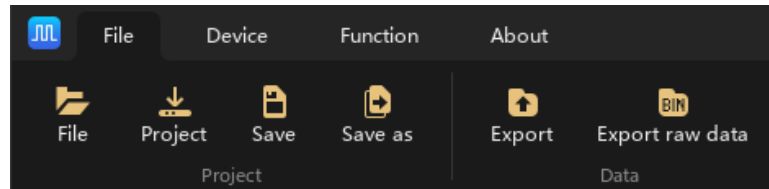

#### Waveform Data Export Steps:

1. Open the ‘File’ option from the top-left toolbar and select ‘Export’ to save waveform data.

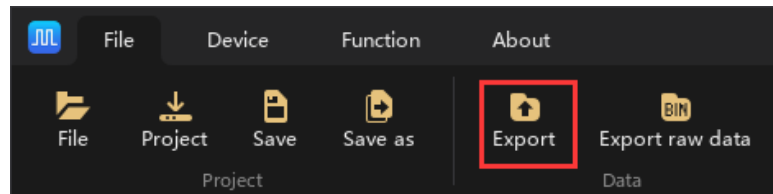

2. Open the ‘File’ option from the top-left toolbar and select ‘Export Raw Data’ to save the raw sampled waveform data.

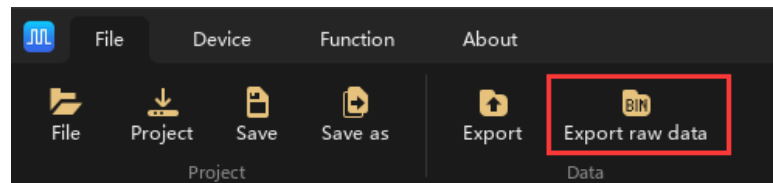

- **Drag-and-Drop File Import:** You can drag files into the session’s internal area to import projects (connecting to a device is required before importing projects). Dragging files into areas other than the internal area opens the files and supports batch file opening.

## 5.21 Habitual Settings

ATK-Logic software provides a selection of commonly used settings for users to customize. To access these settings, open ‘Function’ -> ‘Settings’ from the top-left toolbar and choose ‘Common’.

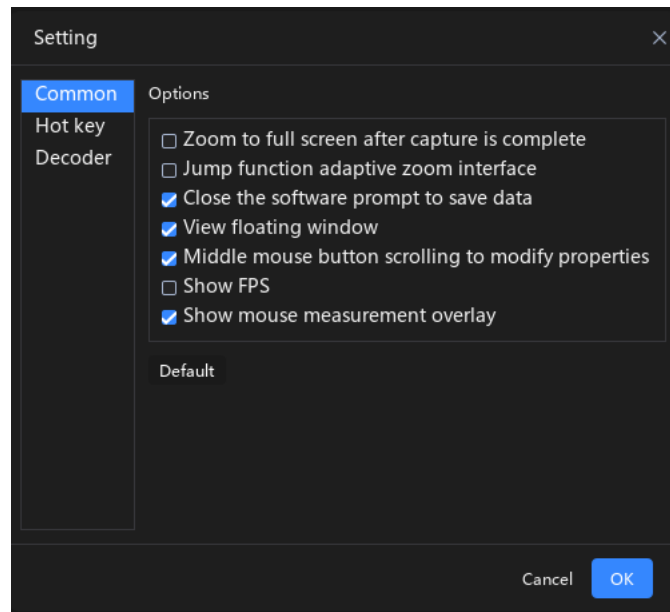

## 5.22 Hot Key

"ATK-Logic software offers specific keyboard shortcuts for frequently used functions, and you can customize these shortcuts as per your preference. To access and configure keyboard shortcuts, open 'Function' -> 'Settings' from the top-left toolbar, and select 'Keyboard Shortcuts'."

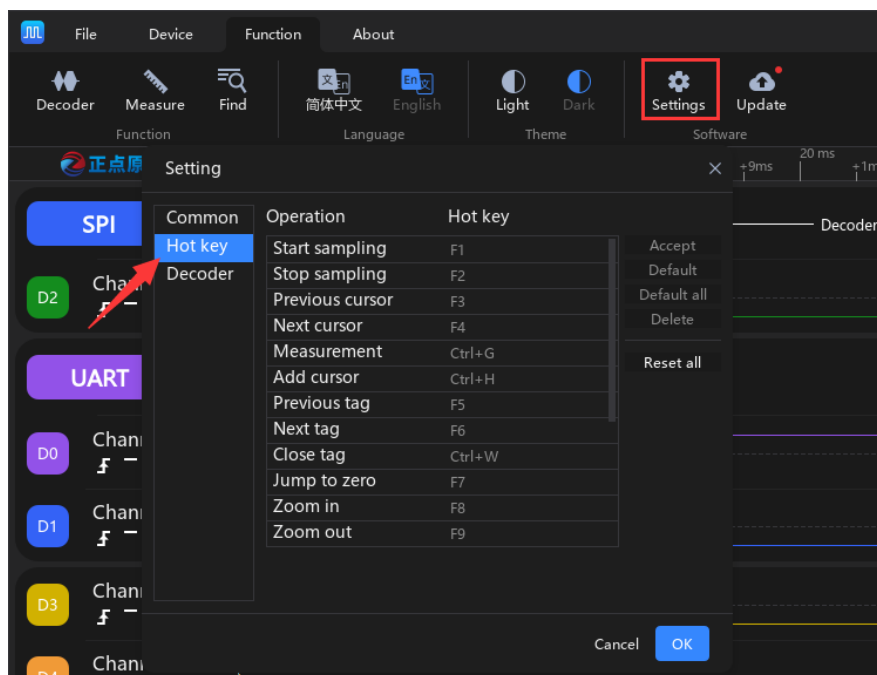

## 5.23 Firmware Update

ATK-Logic software provides firmware update functionality for the logic analyzer, allowing users to easily access new features. The specific upgrade steps are as follows:

- Open the ‘Firmware Upgrade’ interface: Open ‘Device’ -> ‘Update’ from the top-left toolbar. If it says ‘Latest firmware already installed,’ it means your firmware is up to date. Otherwise, you can proceed with the firmware update.

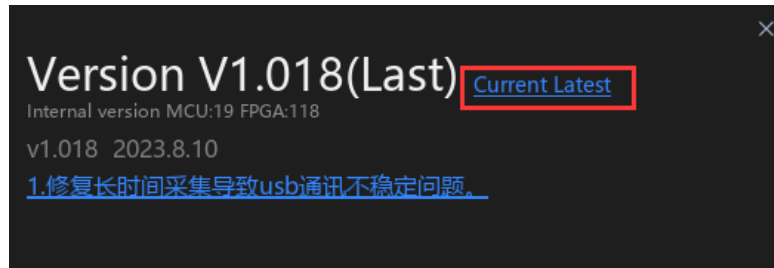

- Select ‘Update’ to update the firmware of the logic analyzer device. You can observe the update progress in the bottom-left status bar.

**Special Note: Please do not plug or unplug the device randomly during firmware updates!**

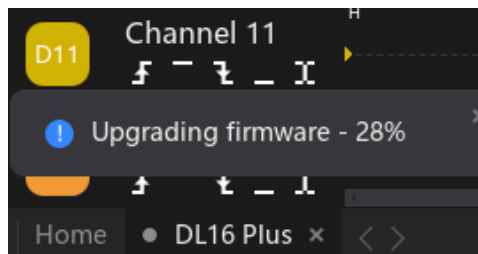

## 5.24 Software update

ATK-Logic software also provides an update feature. To access it, open ‘Function’ -> ‘Update’ from the top-left toolbar. If a new version is available, clicking ‘Update’ will update the software. In the image below, it says ‘Latest version already installed,’ so there’s no need to update.

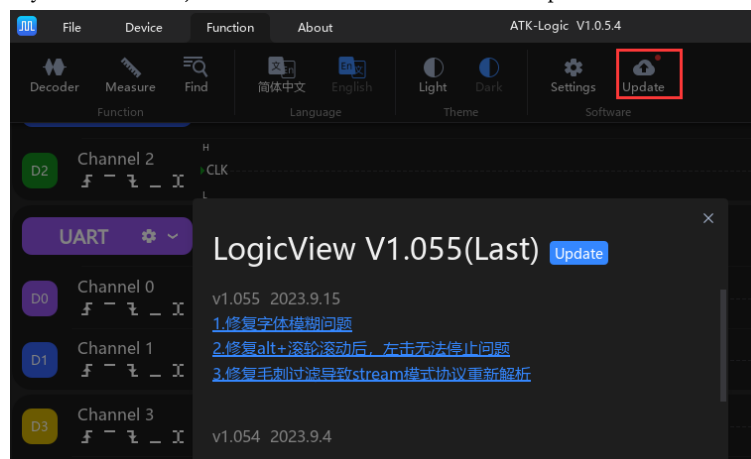

## 6, Others

### 1. After – sales Service:

DL16/DL16 Plus host has a one-year free warranty service in the case of non-artificial damage. Please contact the dealer for warranty service.

## 2. Website

Download : [www.lientek.com/download](http://www.lientek.com/download)

Company : [www.lientek.com](http://www.lientek.com)

Aliexpress : [www.aliexpress.com/store/1102909571](http://www.aliexpress.com/store/1102909571)

## 3. Contact US

E-mail : [fae-smt@lientek.com](mailto:fae-smt@lientek.com)

